

**FLUKE®**

# **Model 187 & 189**

True RMS Multimeter

Users Manual

August 2000, Rev.1, 1/01

© 2000, 2001 Fluke Corporation. All rights reserved. Printed in U.S.A.  
All product names are trademarks of their respective companies.

### **LIFETIME LIMITED WARRANTY**

Each Fluke 20, 70, and 180 Series DMM purchased after October 1, 1996 will be free from defects in material and workmanship for its lifetime. This warranty does not cover fuses, disposable batteries and damage from neglect, misuse, contamination, alteration, accident or abnormal conditions of operation or handling, including overvoltage failures caused by use outside the DMMs specified rating, or normal wear and tear of mechanical components. This warranty covers the original purchaser only and is not transferable.

For ten years from the date of purchase, this warranty also covers the LCD. Thereafter, for the lifetime of the DMM, Fluke will replace the LCD for a fee based on then current component acquisition costs.

To establish original ownership and prove date of purchase, please complete and return the registration card accompanying the product. Fluke will, at its option, repair at no charge, replace, or refund the purchase price of a defective product purchased through a Fluke authorized sales outlet and at the applicable international price. Fluke reserves the right to charge for importation costs of repair/replacement parts if product purchased in one country is sent for repair elsewhere.

If product is defective, contact your nearest Fluke authorized service center to obtain return authorization information, then send the product to that service center, with a description of the difficulty, postage and insurance prepaid (FOB Destination). Fluke assumes no risk for damage in transit. Fluke will pay return transportation for product repaired or replaced in-warranty. Before making any non-warranty repair, Fluke will estimate cost and obtain authorization, then invoice you for repair and return transportation.

THIS WARRANTY IS YOUR ONLY REMEDY. NO OTHER WARRANTIES, SUCH AS FITNESS FOR A PARTICULAR PURPOSE, ARE EXPRESSED OR IMPLIED. FLUKE SHALL NOT BE LIABLE FOR ANY SPECIAL, INDIRECT, INCIDENTAL OR CONSEQUENTIAL DAMAGES OR LOSSES, INCLUDING LOSS OF DATA, ARISING FROM ANY CAUSE OR THEORY. AUTHORIZED RESELLERS ARE NOT AUTHORIZED TO EXTEND ANY DIFFERENT WARRANTY ON FLUKE'S BEHALF. Since some states do not allow the exclusion or limitation of an implied warranty or of incidental or consequential damages, this limitation of liability may not apply to you. If any provision of this warranty is held invalid or unenforceable by a court or other decision-maker of competent jurisdiction, such holding will not affect the validity or enforceability of any other provision.

Fluke Corporation  
P.O. Box 9090  
Everett, WA 98206-9090  
U.S.A.

Fluke Europe B.V.  
P.O. Box 1186  
5602 BD Eindhoven  
The Netherlands

# Table of Contents

Chapter	Title	Page
<b>1</b>	<b>Before You Start .....</b>	<b>1-1</b>
	Safety Information.....	1-1
	Contacting Fluke.....	1-1
	Symbols .....	1-4
<b>2</b>	<b>Getting Acquainted.....</b>	<b>2-1</b>
	Introduction .....	2-1
	Turning the Meter On.....	2-1
	Battery Considerations .....	2-2
	Automatic Power Off .....	2-2
	Automatic Backlight Off.....	2-3
	Low Battery Indication.....	2-3
	Rotary Switch.....	2-4
	Pushbuttons.....	2-5

Selecting the Range.....	2-10
Understanding the Display .....	2-10
Primary Display .....	2-10
Secondary Display.....	2-11
Bar Graph.....	2-11
Using the Input Terminals .....	2-17
Using Display Hold.....	2-18
Using AutoHOLD.....	2-19
Using MIN MAX.....	2-19
Using FAST MN MX.....	2-21
Using HOLD with MIN MAX or FAST MN MX.....	2-22
Using Relative Mode (REL).....	2-22
<b>3    <b>Making Measurements</b>.....</b>	<b>3-1</b>
Introduction .....	3-1
Measuring Voltage .....	3-1
Measuring AC Voltage.....	3-2
dB Measurements in AC Volts Functions .....	3-3
Measuring DC Voltage .....	3-4
Both AC and DC Voltage Measurements .....	3-4
Measuring Resistance .....	3-6
Testing for Continuity .....	3-8
Using Conductance for High Resistance Tests .....	3-9
Measuring Capacitance.....	3-12
Testing Diodes .....	3-13
Measuring Temperature.....	3-15
Measuring Current .....	3-16
Input Alert™ Feature .....	3-17

	Measuring AC Current .....	3-18
	Measuring DC Current .....	3-20
	Measuring Frequency .....	3-22
	Measuring Duty Cycle.....	3-23
	Measuring Pulse Width.....	3-25
<b>4</b>	<b>Using Memory &amp; Communications Features .....</b>	<b>4-1</b>
	Introduction .....	4-1
	Types of Memory .....	4-1
	Saved Readings Memory.....	4-1
	Logged Readings Memory.....	4-1
	Storing Saved Readings .....	4-2
	Starting Logging .....	4-2
	Stopping Logging.....	4-2
	Viewing Memory Data.....	4-3
	Clearing Memory .....	4-5
	Using Communications (187 and 189) .....	4-5
<b>5</b>	<b>Changing the Default Settings .....</b>	<b>5-1</b>
	Introduction .....	5-1
	Selecting Setup Options .....	5-1
	Adjusting the Temperature Offset.....	5-4
	Selecting Display Resolution (3 1/2 or 4 1/2 Digits).....	5-6
	Setting the Power Off Timeout.....	5-6
	Setting the 24-Hour Clock.....	5-7
	Setting the Line (Main) Frequency.....	5-7
	Returning to Factory Defaults .....	5-8
	Saving Setup Options .....	5-8

<b>6</b>	<b>Maintenance .....</b>	<b>6-1</b>
	Introduction .....	6-1
	General Maintenance .....	6-1
	Testing the Fuses.....	6-1
	Replacing the Batteries .....	6-3
	Replacing the Fuses .....	6-5
	User-Replaceable Parts .....	6-5
	In Case of Difficulty .....	6-5
<b>7</b>	<b>Specifications.....</b>	<b>7-1</b>
	Safety and Compliances .....	7-1
	Physical Specifications.....	7-2
	Feature Summary.....	7-3
	Basic Specifications .....	7-4
	Detailed Accuracy Specifications .....	7-5
	Frequency Counter Sensitivity .....	7-11
	Burden Voltage (A, mA, $\mu$ A).....	7-11
	Input Characteristics.....	7-12

# ***List of Tables***

<b>Table</b>	<b>Title</b>	<b>Page</b>
1-1.	Safety Information.....	1-2
1-2.	International Electrical Symbols.....	1-4
2-1.	Rotary Switch Selections .....	2-6
2-2.	Pushbuttons .....	2-8
2-3.	Display Features .....	2-13
3-1.	Current Measurement .....	3-16
4-1.	View Display .....	4-4
5-1.	Function Specific Setup Selections.....	5-2
5-2.	Common Setup Selections .....	5-3
6-1.	User-Replaceable Parts.....	6-6





# List of Figures

Figure	Title	Page
2-1.	AC Volts Display .....	2-2
2-2.	Rotary Switch.....	2-4
2-3.	Pushbuttons.....	2-5
2-4.	Display Features .....	2-12
2-5.	Input Terminals .....	2-17
2-6.	Display Hold and AutoHOLD .....	2-18
2-7.	Min Max Avg .....	2-21
2-8.	Relative Mode.....	2-22
3-1.	AC Voltage Measurement.....	3-2
3-2.	dBm Display.....	3-3
3-3.	AC and DC Display.....	3-5
3-4.	DC Voltage Measurement.....	3-6
3-5.	Resistance Measurement .....	3-7
3-6.	Continuity Test.....	3-10
3-7.	Conductance Measurement.....	3-11
3-8.	Capacitance Measurement.....	3-13
3-9.	Diode Test .....	3-14

## **Model 187 & 189**

### *Users Manual*

---

3-10. Temperature Measurement .....	3-15
3-11. AC Current Measurement.....	3-19
3-12. DC Current Measurement .....	3-21
3-13. Functions Allowing Frequency Measurement.....	3-22
3-14. Hz Display .....	3-23
3-15. Duty Cycle Measurements .....	3-24
3-16. Duty Cycle Display .....	3-25
3-17. Pulse Width Measurements.....	3-26
3-18. Pulse Width Display .....	3-27
4-1. View Display.....	4-4
5-1. Adjusting Temperature Offset .....	5-5
6-1. Testing the Current Fuses.....	6-2
6-2. Battery and Fuse Replacement.....	6-4

# Chapter 1

## Before You Start

### Safety Information

The Fluke Model 187 and Model 189 True RMS Multimeters (hereafter referred to as the “meter”) comply with:

- EN61010.1:1993
- ANSI/ISA S82.01-1994
- CAN/CSA C22.2 No. 1010.1-92
- 1000V Overvoltage Category III, Pollution Degree 2
- 600V Overvoltage Category IV, Pollution Degree 2
- UL 3111-1

Use the meter only as specified in this manual. Otherwise, the protection provided by the meter may be impaired. Refer to safety information in Table 1-1.

A **Warning** identifies conditions and actions that pose hazards to the user. A **Caution** identifies conditions and actions that may damage the meter or the equipment under test.

### Contacting Fluke

To order accessories, receive assistance, or locate the nearest Fluke distributor or Service Center, call:

USA: 1-888-99-FLUKE (1-888-993-5853)  
Canada: 1-800-36-FLUKE (1-800-363-5853)  
Europe: +31 402-678-200  
Japan: +81-3-3434-0181  
Singapore: +65-738-5655  
Anywhere in the world: +1-425-446-5500

Address correspondence to:

Fluke Corporation	Fluke Europe B.V.
P.O. Box 9090,	P.O. Box 1186,
Everett, WA 98206-9090	5602 BD Eindhoven
USA	The Netherlands

Visit us on the World Wide Web at: [www.fluke.com](http://www.fluke.com)

**Table 1-1. Safety Information**

**⚠ Warning**

**To avoid possible electric shock or personal injury, follow these guidelines:**

- **Do not use the meter if it is damaged. Before you use the meter, inspect the case. Look for cracks or missing plastic. Pay particular attention to the insulation surrounding the connectors.**
- **Inspect the test leads for damaged insulation or exposed metal. Check the test leads for continuity. Replace damaged test leads before you use the meter.**
- **If this product is used in a manner not specified by the manufacturer, the protection provided by the equipment may be impaired.**
- **Do not use the meter if it operates abnormally. Protection may be impaired. When in doubt, have the meter serviced.**
- **Do not operate the meter around explosive gas, vapor, or dust.**
- **Do not apply more than the rated voltage, as marked on the meter, between terminals or between any terminal and earth ground.**
- **Before use, verify the meter's operation by measuring a known voltage.**
- **When measuring current, turn off circuit power before connecting the meter in the circuit. Remember to place the meter in series with the circuit.**
- **When servicing the meter, use only specified replacement parts.**
- **Use caution when working above 30 V ac rms, 42 V peak, or 60 V dc. Such voltages pose a shock hazard.**
- **Avoid working alone.**

Table 1-1. Safety Information (cont.)

**⚠ Warning**

- When using the probes, keep your fingers behind the finger guards on the probes.
- Connect the common test lead before you connect the live test lead. When you disconnect test leads, disconnect the live test lead first.
- Remove test leads from the meter before you open the battery door.
- Do not operate the meter with the battery door or portions of the cover removed or loosened.
- To avoid false readings, which could lead to possible electric shock or personal injury, replace the batteries as soon as the low battery indicator (🔋) appears.
- Use only type AA batteries, properly installed in the meter case, to power the meter.
- To avoid the potential for fire or electrical shock, do not connect the thermocouples to electrically live circuits.

**Caution**













To avoid possible damage to the meter or to the equipment under test, follow these guidelines:

- Disconnect circuit power and discharge all high-voltage capacitors before testing resistance, continuity, diodes, or capacitance.
- Use the proper terminals, function, and range for your measurements.
- Before measuring current, check the meter's fuses and turn power OFF to the circuit before connecting the meter to the circuit.

## **Symbols**

Symbols used on the meter and in this manual are explained in Table 1-2.

**Table 1-2. International Electrical Symbols**

	AC (Alternating Current)		Earth ground
	DC (Direct Current)		Fuse
	AC and DC		Double insulated
	Battery		Important information
	Complies with relevant Canadian Standards Association directives		Complies with European Union directives
	Inspected and licensed by TÜV Product Services.		Underwriters Laboratories, Inc.

# Chapter 2

## Getting Acquainted

### **Introduction**

Although this manual describes the operation of both Models 187 and 189, all illustrations and examples assume use of Model 189. Additional capabilities with Model 189 are discussed in Chapter 4. These capabilities include the following:

- An enhanced memory function that features an additional position (VIEW MEM) on the rotary switch.
- Logging
- Save
- Memory

### **Turning the Meter On**

To turn the meter on, turn the rotary switch from OFF to any switch setting.

The ac volts function (shown in Figure 2-1) is assumed in the following discussion. You do not need connections to the input terminals at this time.

If you want a view of the full display (all segments illuminated), press and hold **HOLD** while turning the meter on. Release the button when you are done viewing the full display.

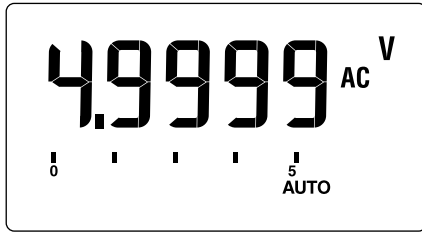

tc031f.eps

**Figure 2-1. AC Volts Display**

## **Battery Considerations**

The meter uses four AA alkaline batteries. The following paragraphs describe several techniques used to conserve battery power.

## **Automatic Power Off**



The display blanks and the meter goes into a “sleep” mode if you have not changed the rotary switch position or pressed a button for a set period. While in Sleep mode, pressing any button turns the meter on. The meter then returns to the display for the function selected with the rotary switch; all previously activated button features (HOLD, Hz, etc.) are discarded.

The automatic power off is preset to 15 minutes. From the Setup menu (see Chapter 5), you can specify a maximum period of 23 hours, 59 minutes. If you set the period to 0, the meter remains on until you turn the rotary switch to OFF or the batteries become too weak.

Automatic power off does not occur if the meter is in MIN MAX, FAST MN MX, AutoHOLD, or LOGGING (Model 189) mode.



### **Automatic Backlight Off**

Press  to select the backlight level (low, high, or off.) In low or high, the backlight turns off automatically after a given period. This period is also preset to 15 minutes and can be set to a maximum of 99 minutes from the setup menu. If the period is set to 0, the backlight is on indefinitely and can only be turned off by pressing  or turning the meter off.

#### *Note*

*See Chapter 5 for power off and backlight off setup information.*

### **Low Battery Indication**

A constant battery icon (  ) in the upper left corner of the display notifies you that the batteries are low and should be replaced.

#### **⚠ Warning**

**To avoid false readings, which could lead to possible electric shock or personal injury, replace the batteries as soon as the battery icon (  ) appears.**

A flashing battery icon means that battery failure is imminent. The backlight cannot be used in this condition. MIN MAX and FAST MN MX features turn off. For Model 189, logging and communications also cease.

## **Rotary Switch**

Turn the meter on by selecting any measurement function (identified with white letters around the rotary switch). The meter presents a standard display for that function (range, measurement units, modifiers, etc.) The display may also be influenced by some of the choices made in Setup.

Use the blue button to select any rotary switch alternate function (labeled in blue letters). You can also use other buttons to choose modifiers for the selected function.

When you turn the rotary switch from one function to another, a display for the new function appears. Button choices made in one function do not carry over into another function.

With Model 189, a VIEW MEM switch position is available; refer to Chapter 4 for more information.

The rotary switch is shown in Figure 2-2. Each position is described in Table 2-1.

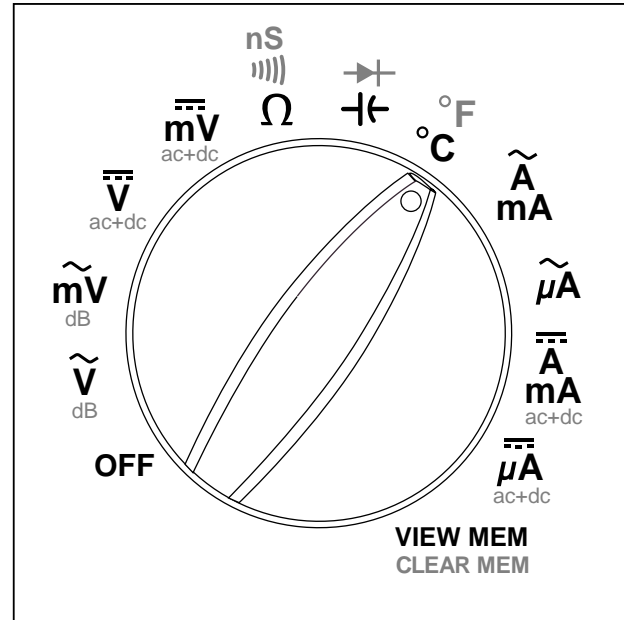

tc012f.eps

**Figure 2-2. Rotary Switch**

## Pushbuttons

The buttons activate features that augment the function selected with the rotary switch. The buttons are shown in Figure 2-3 and described in Table 2-2.

Use the blue button (○) to access functions labeled in blue for some of the rotary switch positions. Table 2-1 defines all blue button functions.

Use the yellow button (□) followed by other buttons to access additional features. These features appear in yellow above the appropriate keys. Table 2-2 defines yellow button features. This manual identifies the yellow button feature in parentheses following the button sequence. For example, activating the FAST MN MX mode appears as □ MIN MAX (FAST MN MX).

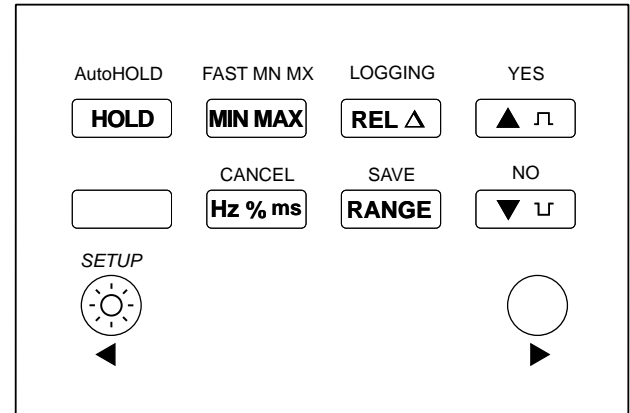

tc013f.eps

Figure 2-3. Pushbuttons

The following yellow button features are not available on Model 187: (YES), (NO), (LOGGING), and (SAVE).

**Table 2-1. Rotary Switch Selections**

Position	Rotary Switch Function	○ Blue Key Function
$\overset{\sim}{\text{V}}$ dB	AC voltage measurement from 0 V to 1000.0 V	dB over AC, AC over dB
$\overset{\sim}{\text{mV}}$ dB	AC millivolt measurement from 0 mV to 3000.0 mV	dB over AC, AC over dB
$\overline{\text{V}}$ ac+dc	DC voltage measurement from 0 V to 1000.0 V	AC over DC (AC in primary display, DC in secondary display), DC over AC, ac+dc
$\overline{\text{mV}}$ ac+dc	DC millivolt measurement from 0 mV to 3000.0 mV	AC over DC (AC in primary display, DC in secondary display), DC over AC, ac+dc
$\Omega$ nS )))	Resistance measurement from 0 $\Omega$ to 500.0 M $\Omega$	Continuity test Conductance measurement from 0 nS to 50.00 nS
$\rightarrow +$ $- \leftarrow$	Capacitance measurement from 0.001 nF to 50 mF	Diode test
$^{\circ}\text{F}$ $^{\circ}\text{C}$	Temperature measurement	Toggles between $^{\circ}\text{C}$ and $^{\circ}\text{F}$ .

**Table 2-1. Rotary Switch Positions (cont.)**

Position	Rotary Switch Function	○ Blue Key Function
<b>A</b> <b>mA</b> ~	AC current measurements from 0 mA to 20.000 A	none
<b>μA</b> ~	AC current measurements from 0 μA to 5000.0 μA	none
<b>A</b> == <b>mA</b> ac+dc	DC current measurements from 0 mA to 20.000 A	AC over DC (AC in primary display, DC in secondary display), DC over AC, ac+dc
<b>μA</b> == <b>μA</b> ac+dc	DC current measurements from 0 μA to 5000.0 μA	AC over DC (AC in primary display, DC in secondary display), DC over AC, ac+dc
<b>VIEW</b> <b>MEM</b>	(Model 189 only.) Access data held in the meter's memory. See Chapter 4 for more information.	CLEAR MEM. See Chapter 4 for more information.

Table 2-2. Pushbuttons













Button	Description	Yellow Button Function	Description
<p><i>Note</i></p> <p>Press <input type="text"/> to access "Yellow Button Functions." The <input type="text"/> box and the 24-hour clock appear in the lower corners of the display and the primary display freezes, allowing time to press a second button.</p>			
	<p>Press to turn backlight on or off. Also, in Setup, use the arrow function (◀) to select the previous digit or item in a list.</p>	<p>SETUP</p> <p><input type="text"/> </p>	<p>Press to access Setup selections. Press to store a Setup selection and proceed to the next selection.</p>
<p><input type="text"/> HOLD</p>	<p>Press to freeze the displayed value. Press again to release the display.</p>	<p>AutoHOLD</p> <p><input type="text"/> <input type="text"/> HOLD</p>	<p>Press to begin AutoHOLD; the last stable reading is displayed.</p>
<p><input type="text"/> MIN MAX</p>	<p>Press to start retaining min, max, and average values. Press successively to display max, min, and average values. Press <input type="text"/> Hz % ms (CANCEL) to stop.</p>	<p>FAST MN MX</p> <p><input type="text"/> <input type="text"/> MIN MAX</p>	<p>Press to start FAST MN MX mode, where min and max values for short duration events are stored.</p>
<p><input type="text"/> REL Δ</p>	<p>Press to store the present reading as an offset reference; subsequent readings show only the relative difference from this value. Press again to show the difference as a percentage of the reference.</p>	<p>LOGGING</p> <p><input type="text"/> <input type="text"/> REL Δ</p>	<p>Press to start and stop Logging (Model 189). Press <input type="text"/> + <input type="text"/> Hz % ms (CANCEL) to stop.</p>

Table 2-2. Pushbuttons (cont.)

Button	Description	Yellow Button Function	Description
	<ul style="list-style-type: none"> <li>In Setup, increment a digit .</li> <li>In counter functions, select positive pulse slope.</li> <li>In ohms continuity, select beep on open.</li> <li>In VIEW MEM, see Chapter 4 (Model 189).</li> </ul>	(none)	
	<ul style="list-style-type: none"> <li>In Setup, decremte a digit .</li> <li>In counter functions, select negative pulse slope.</li> <li>In ohms continuity, select beep on short.</li> <li>In VIEW MEM, see Chapter 4 (Model 189).</li> </ul>	(none)	
	Exit AUTO and enter MANUAL ranging. In MANUAL, select next input range. Press  Hz % ms (CANCEL) to return to AUTO.	SAVE  RANGE	Press to save present reading (Model 189)
	Successively press for frequency, duty cycle, and pulse width.	CANCEL  Hz % ms	CANCEL any  (blue key) function and all other button features.
 	The blue button. Press to access blue functions on the rotary switch. In Setup, use arrow function (  ) to select the next digit or item in a list.	(none)	

## Selecting the Range

Press **RANGE** to select either a fixed range or the autorange feature.

### Note

*You cannot use **RANGE** in conductance, diode test, and temperature functions or with the REL, MIN MAX, and FAST MN MX features. These selections all use a specific fixed range.*

Autoranging (AUTO lighted in the display) always comes on initially when you select a new function. In autorange, the meter selects the lowest input range possible, ensuring that the reading appears with the highest available precision (resolution).

If AUTO is already on, press **RANGE** to enter MANUAL ranging in the present range. You can then select the next manual range each time you press **RANGE**. Return to autoranging by pressing **Hz % ms** (CANCEL).

## Understanding the Display

Display features are shown in Figure 2-4 and described in Table 2-3. Major display features are described in the following paragraphs.

### Note

*You can show all display segments (as shown in Figure 2-4) by pressing **HOLD** while turning the meter on. Release **HOLD** to turn off the full display.*

## Primary Display

The primary display usually shows the present reading for the rotary switch function. For most of these functions, the primary display can be set to show 4 or 5 digits. See Chapter 5 for more information about display digits.

Other uses for this display are:

- AutoHOLD: most recent held reading.
- MIN MAX: maximum, minimum, or average value.



- dB (in ac volts functions): the dBm or dBV value.
- REL: the difference between the present reading and a stored reference reading.
- Setup: various messages (see Chapter 5).
- Overload conditions: OL displayed.
- Error conditions.

### **Secondary Display**

The secondary display often shows the present reading when the primary display shows some other feature (MIN MAX, REL  $\Delta$ , etc.)

When multiple features are active, the secondary display shows one of the values. For example, Hz could appear in the secondary display while dB appears in the primary display.

### **Bar Graph**

The bar graph provides an analog indication of the measured input. For most measurement functions, the bar graph updates 40 times per second. Since this response is much faster than the digital display, the bar graph is useful for making peak and null adjustments and for observing rapidly changing inputs. The bar graph is not available in temperature, capacitance, ac over dc, dc over ac, and ac+dc functions.

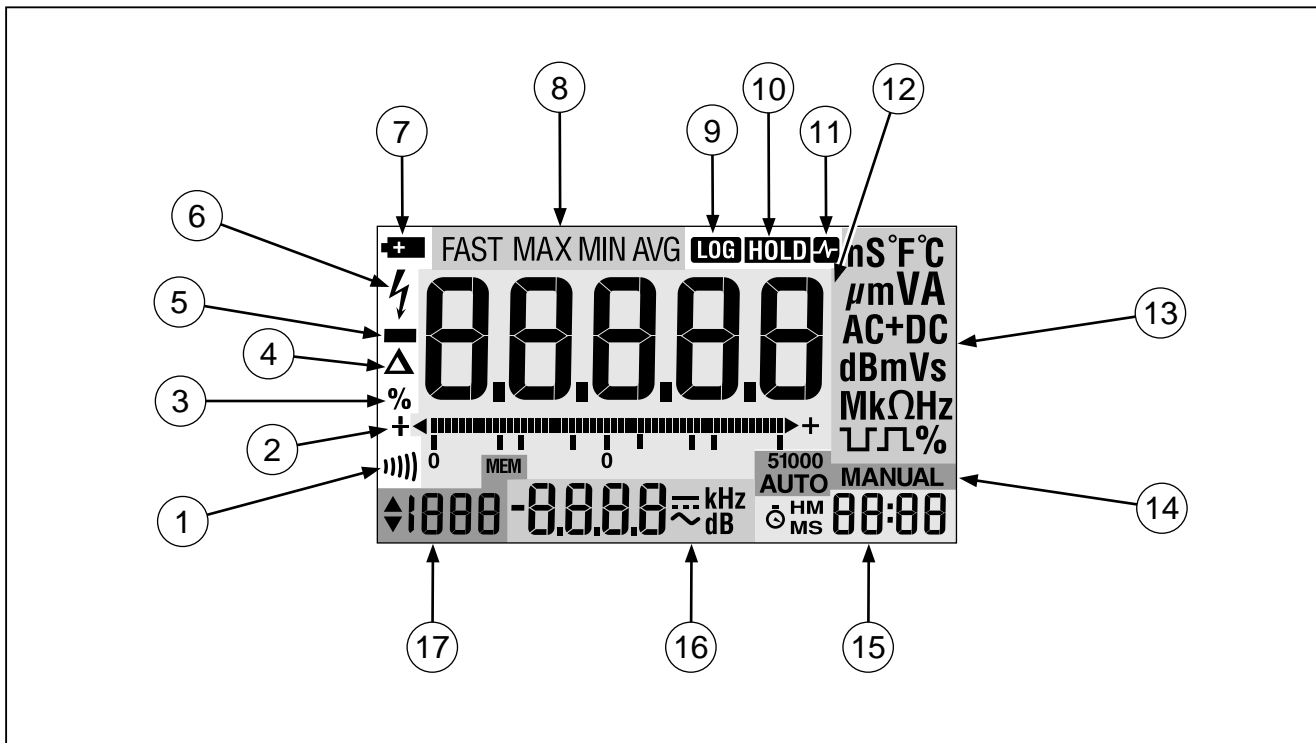
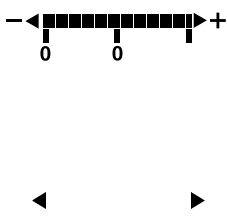





Figure 2-4. Display Features

tc011f.eps

**Table 2-3. Display Features**

Number	Feature	Description
①	)	Continuity test function is selected.
②		<p>Bar Graph.</p> <p>In normal operation 0 (zero) is on the left. In Relative %, 0 is in the center, negative values are to the left and positive to the right.</p> <p>The polarity indicator left of the bar graph shows the polarity of the input. Both polarity indicators appear in REL% mode.</p> <p>The arrow right of the bar graph indicates an overload condition.</p> <p>Both arrows appear (without bar graph) when you can use  (◀) and  (▶) to select settings in the setup mode.</p>
③	%	Percent difference in Relative mode is being displayed in the primary display. The reference value is shown in the secondary display
④	Δ	Relative (REL Δ) mode is active. The primary display has been modified by the reference value shown in the secondary display.
⑤	■	Indicates negative readings. In Relative mode, this sign indicates that the present input is less than the stored reference.
⑥	⚡	>30 V ac and/or dc may be present at the input terminals.
⑦	+■	<p>Low battery. If flashing, battery failure is imminent, and logging and backlight are disabled.</p> <p style="text-align: center;"><b>⚠ Warning</b></p> <p><b>To avoid false readings, which could lead to possible electric shock or personal injury, replace the battery as soon as the low battery indicator appears.</b></p>

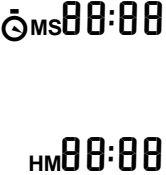



**Table 2-3. Display Features (cont.)**

Number	Feature	Description
⑧	<b>FAST</b> <b>MIN</b> <b>MAX</b> <b>AVG</b>	FAST MN MX mode is enabled. ( <input type="checkbox"/> <b>MIN MAX</b> ) Minimum reading displayed. Maximum reading displayed. Average reading displayed.
⑨	<b>LOG</b>	Readings are being recorded in memory (Model 189 only.) ( <input type="checkbox"/> + <b>REL Δ</b> )
⑩	<b>HOLD</b>	The meter is in Hold mode. ( <b>HOLD</b> )
⑪	<b>HOLD</b> 	AutoHOLD is active. ( <input type="checkbox"/> + <b>HOLD</b> )
⑫	<b>0.0.0.0.0</b>	Primary Display (4-1/2 digit)
	<b>OL</b>	Overload input.
⑬		Measurement Units
	<b>V, mV</b>	V: Volts. The unit of voltage. mV: Millivolt. $1 \times 10^{-3}$ or 0.001 volts.
	<b>dBm, dBV</b>	For ac volts functions, reading is shown in decibels of power above or below 1 mW (dBm) or decibels of voltage above or below 1 V (dBV).

**Table 2-3. Display Features (cont.)**

Number	Feature	Description
⑬	<b>AC+DC</b>	For dc volts and dc amps functions, reading represents the rms total of ac and dc measurements.
	<b>Ω, kΩ MΩ,</b>	Ω: Ohm. The unit of resistance. kΩ: Kiloohm. $1 \times 10^3$ or 1000 ohms. MΩ: Megohm. $1 \times 10^6$ or 1,000,000 ohms.
	<b>nS</b>	S: Siemens. The unit of conductance. nS: Nanosiemens. $1 \times 10^{-9}$ or 0.000000001 Siemens.
	<b>nF, μF, mF</b>	F: Farad. The unit of capacitance. nF: Nanofarad. $1 \times 10^{-9}$ or 0.000000001 farads. μF: Microfarad. $1 \times 10^{-6}$ or 0.000001 farads. mF: Millifarad. $1 \times 10^{-3}$ or 0.001 farads.
	<b>°C , °F</b>	Degrees Celsius (default) or Fahrenheit.
	<b>A, mA, μA</b>	A: Amperes (amps). The unit of current. mA: Milliamp. $1 \times 10^{-3}$ or 0.001 amperes. μA: Microamp. $1 \times 10^{-6}$ or 0.000001 amperes.
	<b>Hz, kHz, MHz</b>	Hz: Hertz. The unit of frequency. kHz: Kilohertz. $1 \times 10^3$ or 1000 hertz. MHz: Megahertz. $1 \times 10^6$ or 1,000,000 hertz.

**Table 2-3. Display Features (cont.)**

Number	Feature	Description
⑭	<b>51000</b> <b>AUTO      MANUAL</b>	Range. Digits display range in use.
⑮		<p>Time Display. Used with HOLD, AutoHOLD, MIN MAX, FAST MN MX (SAVE, and LOGGING Model 189).</p> <p>Elapsed Time Display (⦿ on): shown in minutes:seconds to maximum of 59:59 - used if time since Min, Max, or Logging started is less than 60 minutes. Always used for Min, Max, Avg. Displays hours:minutes after 1 hour.</p> <p>24-hour Display (⦿ off): shown in hours:minutes to maximum of 23:59. For setting the 24-hour clock, refer to Chapter 5.</p>
⑯	<b>0.0.0.0</b>	Secondary Display
⑰	<b>MEM</b> 	<p>Memory Index Display (Model 189). Also used for dBm reference resistance.</p> <p>⬆ appears when you can use  and  to increment or decrement settings.</p>

## Using the Input Terminals

All functions except current use the  $\Omega$   $\rightarrow$   $\oplus$  and COM inputs. Current functions use the inputs shown below:

- $\overset{\text{TEMPERATURE}}{\overset{\text{A}}{\text{mA}}}$  or  $\overset{\text{A}}{\text{mA}}_{\text{ac/dc}}$  function: Use A and COM inputs from 400 mA to 20 A. Use mA/ $\mu$ A and COM for inputs  $\leq$  400 mA.
- $\overset{\text{TEMPERATURE}}{\overset{\mu\text{A}}{\mu\text{A}}}$  or  $\overset{\mu\text{A}}{\mu\text{A}}_{\text{ac/dc}}$  function: Use mA/ $\mu$ A and COM for inputs  $\leq$  5000.0  $\mu$ A.

If a test lead is plugged into the mA/ $\mu$ A or A terminal, but the rotary switch is not correctly set to one of the current measuring positions, the Input Alert™ beeper warns you by making a chirping sound and the primary display shows "L E Ad5". This warning is intended to stop you from attempting to measure voltage, continuity, resistance, capacitance, or diode values when the leads are plugged into a current terminal.

Figure 2-5 shows the input terminals.

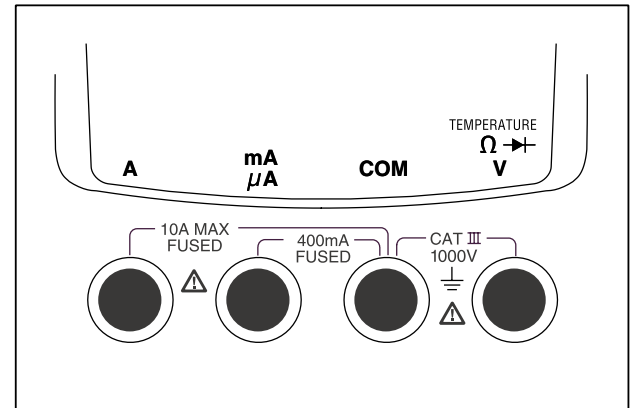

tc014f.eps

Figure 2-5. Input Terminals

## Using Display Hold

Press **HOLD** to enter the Display Hold mode and freeze the present reading and its time stamp. New readings now appear in the secondary display. See Figure 2-6. To exit Display Hold mode, press **HOLD** again.

### Note

*The bar graph and secondary display may show different units in Capacitance and Ohms due to Autoranging.*

In the MIN MAX mode, Display Hold functions like a toggle, interrupting and resuming the MIN MAX operations.

With Model 189, you cannot use Display Hold while logging data. Model 189 allows you to save the frozen reading to memory by pressing **RANGE** (SAVE).

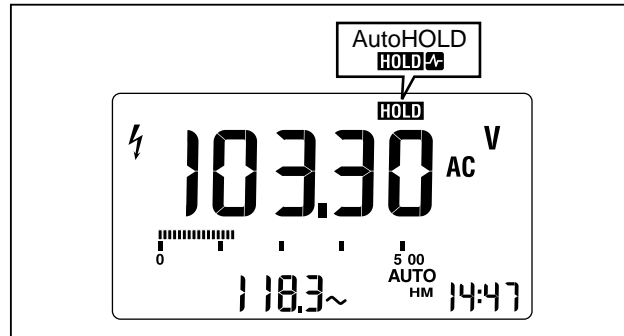

tc040f.eps

Figure 2-6. Display Hold and AutoHOLD



## Using AutoHOLD

### **⚠ Warning**

**AutoHOLD mode does not capture unstable or noisy readings. Do not use AutoHOLD mode to determine that circuits are without power.**

To enter AutoHOLD, press  **HOLD** (AutoHOLD). AutoHOLD mode freezes the present reading and its time stamp. New readings now appear in the secondary display. See Figure 2-6. When the meter detects a new, stable reading (>4% change from last stable reading), it beeps and displays the new reading in the primary display. You can also force a primary display update by pressing  **HOLD**.

If you remove the test leads (open the input), the meter retains the last frozen primary display.

You cannot use AutoHOLD when MIN MAX is active. With Model 189, you cannot initiate AutoHOLD while logging data, but you can initiate logging when AutoHOLD is active.

To exit AutoHOLD mode, press  **HOLD** (AutoHOLD) again.

## Using MIN MAX

The MIN MAX mode stores minimum (MIN) and maximum (MAX) input values. When the input goes below the stored minimum value or above the stored maximum value, the meter beeps and stores the new value. MIN MAX mode also calculates an average (AVG) of all readings taken since the mode was activated.

Press  **MIN MAX** to enter the MIN MAX mode. The maximum (MAX) reading is displayed first.

Each subsequent press of  **MIN MAX** steps through the minimum (MIN), average (AVG), and back to the maximum reading.

In the MIN MAX mode, the secondary display continues to show the present measurement value.

The time elapsed since the MIN MAX mode was entered is shown in the bottom right corner of each type of display. See Figure 2-7.

## Model 187 & 189

### Users Manual

---

To exit MIN MAX mode, press  (CANCEL) or turn the rotary switch to a different position. Also, MIN MAX mode turns off automatically when a flashing  (low battery condition) occurs.

#### Note

*Minimum, maximum, and average values stored in the MIN MAX mode are lost when the meter is turned off.*

The MIN MAX mode can be used to capture intermittent readings, store maximum readings while you are away, or store readings while you are operating the equipment under test and cannot watch the meter. The average reading is useful for smoothing out unstable inputs, calculating power consumption, or estimating the percent of time a circuit is active.

The MIN MAX mode is appropriate for storing signal events that last 50 ms or longer in most measurement functions. Signal events must be 500 ms or longer in the following functions: continuity, conductance, capacitance, temperature, Hz, duty cycle, and pulse width.

## Using FAST MN MX

FAST MN MX can capture transient signal events as short as 250  $\mu$ s, but with decreased accuracy; only 3-1/2 display digits are allowed.

Activate FAST MN MX by pressing  **MIN MAX**. As with regular MIN MAX, you can then press **MIN MAX** to cycle through maximum, minimum, and average primary displays. The meter beeps for any new minimum or maximum value. Exit FAST MN MX by pressing  **Hz % ms** (CANCEL) or by turning the rotary switch.

A low battery condition (flashing ) disables FAST MN MX.

In ac measurement functions, MAX and MIN values are peak values, AVG is the rms value. This provides the necessary information in one display for calculation of Crest Factor (peak/rms).

Due to longer required response times, you cannot use FAST MN MX in the following functions: ohms, diode test, conductance, continuity, capacitance, temperature, ac over dc, ac+dc, Hz, duty cycle, and pulse width.

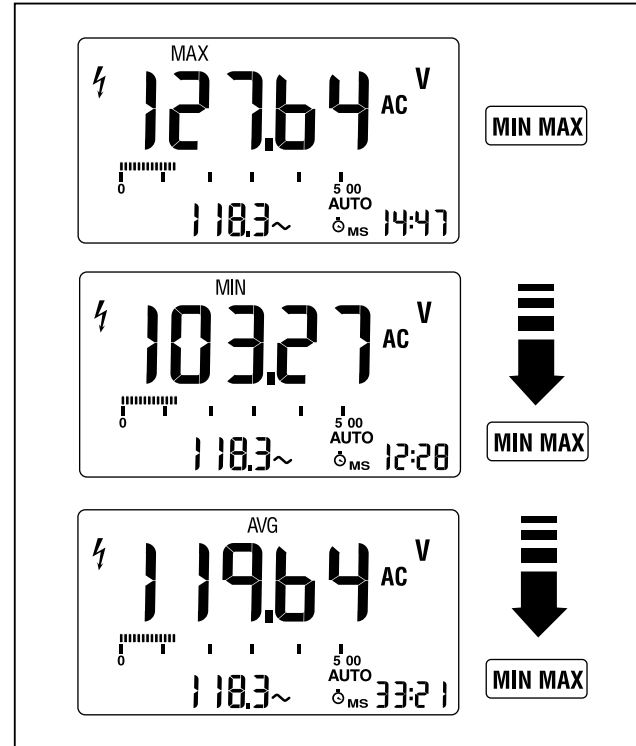

Figure 2-7. Min Max Avg

tc033f.eps

### **Using HOLD with MIN MAX or FAST MN MX**

You can enable the HOLD mode when in the MIN MAX mode is by pressing **HOLD**.

No further minimum, maximum, or average updates occur while the HOLD mode is enabled.

Exit HOLD mode by pressing **HOLD** a second time.

### **Using Relative Mode (REL)**

Selecting Relative mode (**REL Δ**) causes the meter to zero the display and store the present reading as a reference for subsequent measurements.

- Press **REL Δ** once to select the Relative Mode. (The meter enters manual range when you enter the Relative Mode.)

The reference appears in the secondary display. The difference between the reference and a new measurement appears in the primary display. See Figure 2-8.

- Press **REL Δ** a second time to enter the REL% mode and display the difference as  $\pm 10\%$  of the reference reading.

In REL%,  $\Delta\%$  appears on the display.

- Press **REL Δ** a third time to exit the Relative Mode.

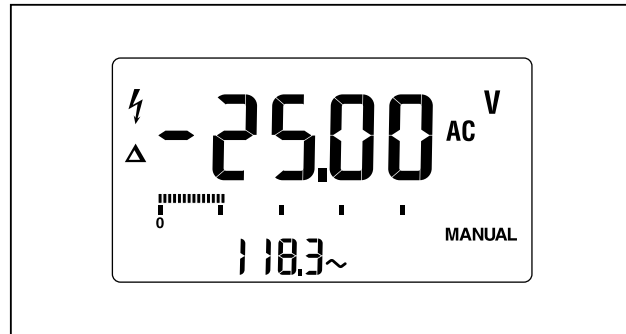

tc039f.eps

**Figure 2-8. Relative Mode**

# Chapter 3

## Making Measurements

### Introduction

Chapter 3 explains how to make measurements. Most measurement functions can be selected by using the rotary switch.

White letters or symbols identify primary functions; blue letters or symbols identify alternative functions. Press the blue button to access these alternate functions.

Frequency-related functions can be selected (Hz, duty cycle, and pulse width) when the rotary switch is in any volts or amps position.

### Measuring Voltage

Voltage is the difference in electrical potential between two points. The polarity of ac (alternating current) voltage varies over time, while the polarity of dc (direct current) voltage is constant over time.

Ranges available in volts functions are:

- $\text{dB } \tilde{\text{V}}_{\text{ac+dc}} \overline{\text{V}}$   
5.0000 V, 50.000 V, 500.00 V, 1000.0 V

- $\text{dB } \tilde{\text{mV}}_{\text{ac+dc}} \overline{\text{mV}}$   
50.000 mV, 500.00 mV, and 5000.0 mV

Readings in the 5000.0 mV range overload (OL) near 3000 mV ac or dc. The 5000.0 mV range overlaps the 5.0000 V range to provide direct reading display for Fluke accessories that have a millivolt output with limits scaled by 1000. For example, the Fluke 80i-1000 Current Clamp provides 1 mV ac per amp measured up to 1000 amps.

When measuring voltage, the meter acts like a 10 M $\Omega$  (10,000,000  $\Omega$ ) impedance in parallel with the circuit. This loading effect can cause measurement errors in high-impedance circuits. In most cases, the error is negligible (0.1% or less) if the circuit impedance is 10 k $\Omega$  (10,000  $\Omega$ ) or less.

### **Measuring AC Voltage**

The meter presents ac voltage values as rms (root mean square) readings. The rms value is the equivalent dc voltage that would produce the same amount of heat in a resistance as the measured voltage. Your meter features true rms readings, which are accurate for sinewaves and other wave forms (with no dc offset) such as square waves, triangle waves, and staircase waves. For ac with dc offset, use  $\overline{\overline{V}}$ .

Set up the meter to measure ac volts as shown in Figure 3-1.

All pushbutton features are available in this function. The blue button (○) accesses decibel dBm or dBV) measurements, discussed next in this chapter.

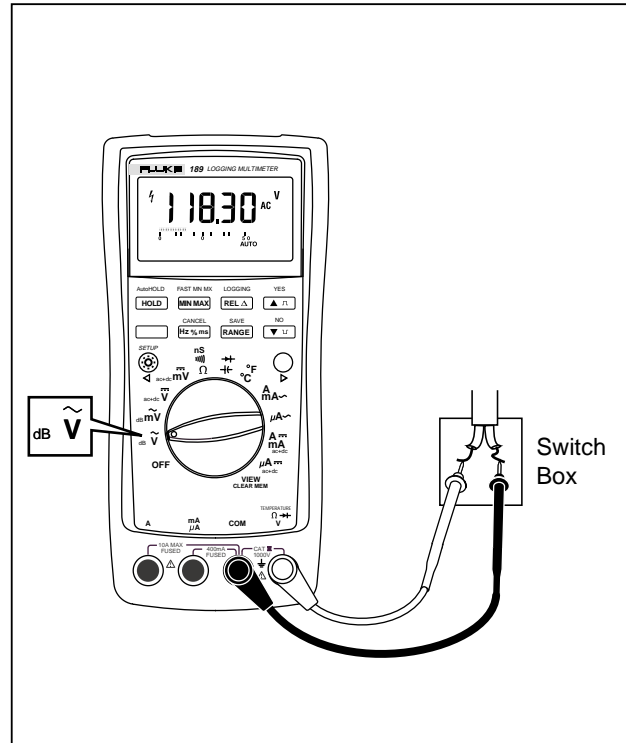

**Figure 3-1. AC Voltage Measurement**

ach001f.eps

### ***dB Measurements in AC Volts Functions***

The two ac volts functions allow you to display readings as deviations in dB (decibels) above or below an established level.

Set up dB measurements with the following procedure:

1. Make an ac volts measurement to be used as a reference point.
2. Press  $\bigcirc$  to select dB. The dBm (or dBV) value appears in the primary display and the ac volts reading appears in the secondary display. A typical dB display appears in Figure 3-2.
3. Press  $\bigcirc$  again to switch the ac volts and dB readings. Press  $\bigcirc$  a third time to turn dB off.

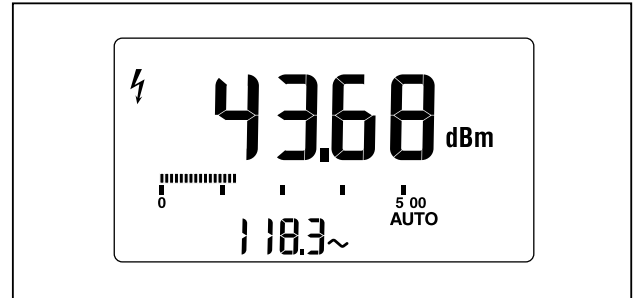

tc032f.eps

**Figure 3-2. dBm Display**

Normally, dB is measured as dBm, which is a measure of decibels relative to 1 milliwatt. The meter assumes a resistance of 600  $\Omega$  in making this calculation. This resistance can be set for any value from 1 to 1999  $\Omega$ , using the meter's setup capabilities (see Chapter 5.) When set to other than 600  $\Omega$  the dBm reference resistance appears in the Index Display. (See Figure 2-4, item 17.)

*Note*

*If dBm is displayed, check that the reference resistance value closely matches the impedance of the system being measured.*

dB is calculated with the following formula:

$$dB = 20 * \log_{10} \left[ \frac{V_x}{V_r} \right]$$

- For dBm, Vr is the voltage across the reference resistance at 1 mW. For example, Vr would be 0.7746 V with a 600 Ω reference resistance.
- For dBV, the reference voltage (Vr) is 1 V.

### **Measuring DC Voltage**

Set up the meter for dc voltage measurement as shown in Figure 3-4. All pushbutton features are available for a standard dc volts reading.

### **Both AC and DC Voltage Measurements**

When a dc volts function is selected, the meter can display ac and dc components of a signal separately or the combined ac + dc (rms) value.

To select separate ac and dc signal components:

- Press  once to display ac voltage in the primary display and dc voltage in the secondary display (ac over dc).
- Press  a second time to reverse the displays (dc over ac).
- Press  a third time to display the ac + dc rms value in the primary display. (FAST MN MX is unavailable in this state.)
- Press  a fourth time to return to the normal dc volts display.

Figure 3-3 shows some typical displays.



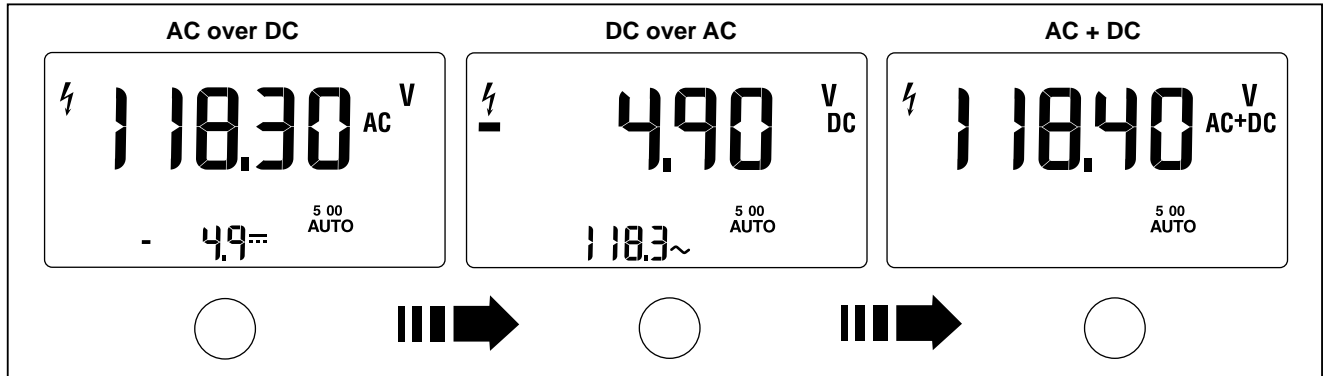

tc024f.eps

Figure 3-3. AC and DC Display

When the meter shows ac over dc or dc over ac, the following other pushbutton functions are not available:

- AutoHOLD (  HOLD )
- MIN MAX ( MIN MAX )
- FAST MN MX (  MIN MAX )
- Hz ( Hz % ms )
- Relative ( REL Δ )
- LOGGING (  REL Δ )

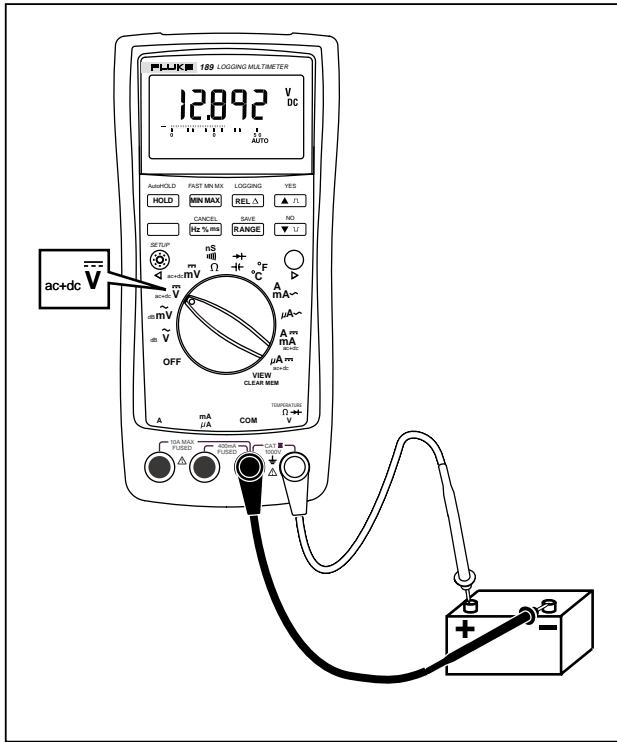

Figure 3-4. DC Voltage Measurement

ach002f.eps

## Measuring Resistance

### Caution

To avoid possible damage to the meter or to the equipment under test, disconnect circuit power and discharge all high-voltage capacitors before measuring resistance.

Resistance is an opposition to current flow. The unit of resistance is the ohm ( $\Omega$ ). The meter measures resistance by sending a small current through the circuit.

The meter's resistance ranges are 500.00  $\Omega$ , 5.0000 k $\Omega$ , 50.000 k $\Omega$ , 500.00 k $\Omega$ , 5.0000 M $\Omega$ , 30.000 M $\Omega$ , and 500.0 M $\Omega$ .

To measure resistance, set up the meter as shown in Figure 3-5.

All pushbutton functions are available with resistance measurements. The blue key cycles to continuity and conductance measurement, which are described later in this chapter.

### Note

*In the Ohms Mode, a negative sign (-) on the display indicates the presence of voltage. This will cause reading errors.*

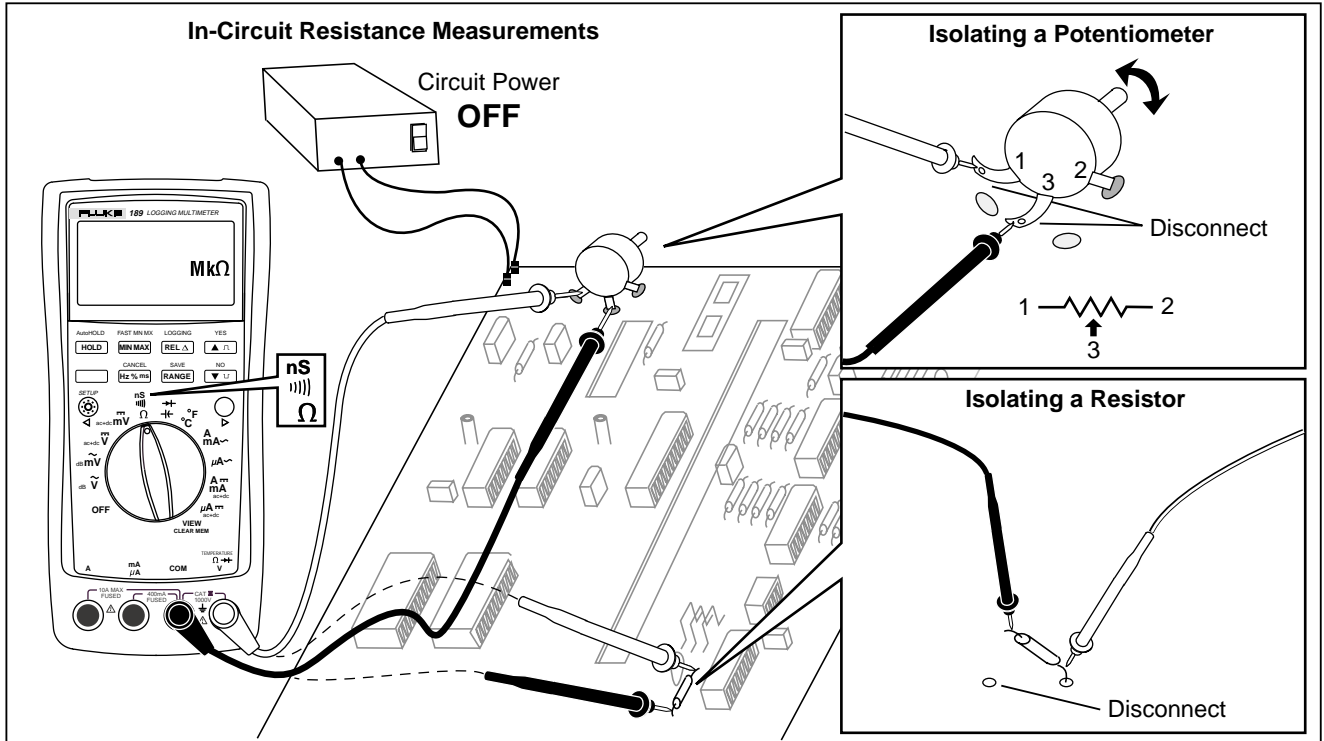

Figure 3-5. Resistance Measurement

ach004f.eps

Keep the following in mind when measuring resistance:

- Because the meter's test current flows through all possible paths between the probe tips, the measured value of a resistor in a circuit is often different from the resistor's rated value.
- The test leads can add 0.1  $\Omega$  to 0.2  $\Omega$  of error to resistance measurements. To test the leads, touch the probe tips together and read the resistance of the leads. If necessary, you can press REL  $\Delta$  to automatically subtract this value.

The resistance function can produce enough voltage to forward-bias silicon diode or transistor junctions, causing them to conduct. To avoid this, do not use the 30 M $\Omega$  or 500 M $\Omega$  ranges for in-circuit resistance measurements.

## **Testing for Continuity**

### **Caution**

**To avoid possible damage to the meter or to the equipment under test, disconnect circuit power and discharge all high-voltage capacitors before testing for continuity.**

Continuity is the presence of a complete path for current flow. The continuity test features a beeper that sounds if a circuit is complete. The beeper allows you to perform quick continuity tests without having to watch the display.

The continuity function detects intermittent opens and shorts lasting as little as 1 millisecond (0.001 second). These brief contacts cause the meter to emit a short beep.

To select continuity, turn the rotary switch to resistance position, then press the blue button once. The continuity symbol (⎓) appears in the display. Continuity uses manual ranging only; autoranging is not available. Refer to Figure 3-6 for continuity testing setup instructions.

Continuity testing provides you with both a visual indication of the state encountered (usually near 0 resistance for a short or OL for an open) and an audible beep when the input is low.

In continuity, a short means a measured value less than 5% of full scale. You can raise this threshold by manually selecting a higher range.

You can select whether the beeper comes on for open or short conditions, as follows:

- Press  to enable the beeper for opens.
- Press  to enable the beeper for shorts.

The Hz () and FAST MN MX () functions are not available when continuity is selected. All other pushbutton functions are available. The blue key cycles among resistance, continuity, and conductance.

## **Using Conductance for High Resistance Tests**

Conductance, the inverse of resistance, is the ability of a circuit to pass current. High values of conductance correspond to low values of resistance.

The unit of conductance is the Siemens (S). The meter's 50 nS range measures conductance in nanosiemens (1 nS = 0.00000001 Siemens). Because such small amounts of conductance correspond to extremely high resistance, the nS range lets you determine the resistance of components up to 100,000 MΩ, or 100,000,000,000 Ω (1 nS = 1,000 MΩ).

To measure conductance, set up the meter as shown in Figure 3-7; then press the blue key until the nS indicator appears on the display.

With conductance measurements, the following pushbutton operations cannot be used:

- Frequency ()
- FAST MN MX ()
- Manual ranging ()

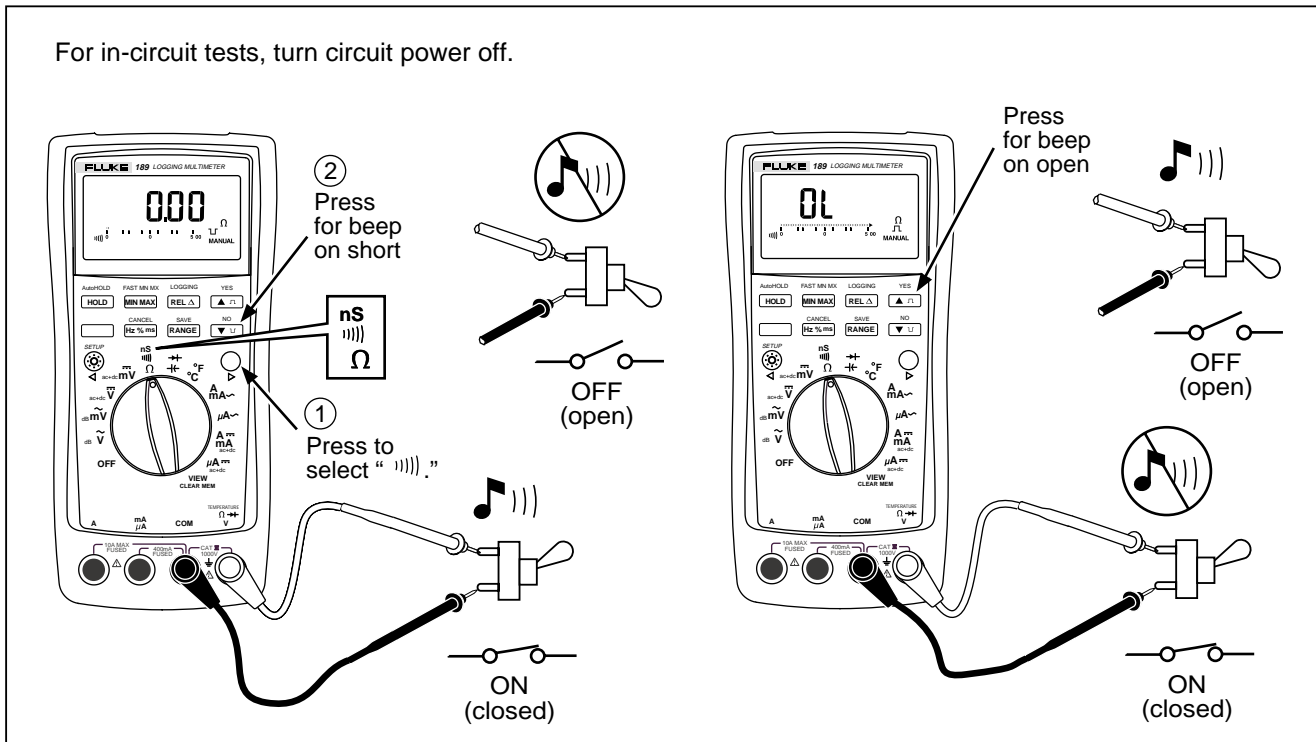
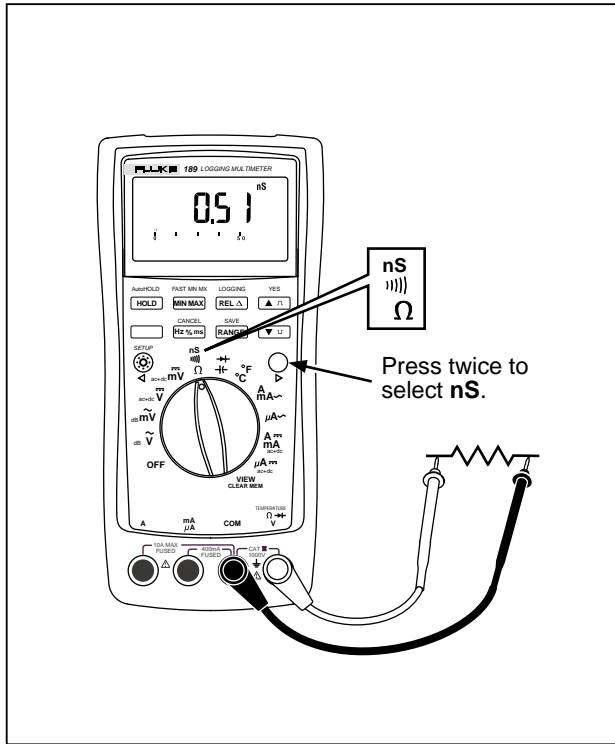

Figure 3-6. Continuity Test

ach003f.eps



ach023f.eps

**Figure 3-7. Conductance Measurement**

The following are some tips for measuring conductance:

- High-resistance readings are susceptible to electrical noise. Use averaging to smooth out most noisy readings; press **MIN MAX** until **AVG** appears in the display.
- There is normally a residual conductance reading with the test leads open. To ensure accurate readings, press **REL Δ** with the test leads open to subtract the residual value.

## Measuring Capacitance

### Caution

**To avoid possible damage to the meter or to the equipment under test, disconnect circuit power and discharge all high-voltage capacitors before measuring capacitance. Use the dc voltage function to confirm that the capacitor is discharged.**

Capacitance is the ability of a component to store an electrical charge. The unit of capacitance is the farad (F). Most capacitors are in the nanofarad (nF) to microfarad ( $\mu$ F) range.

The meter measures capacitance by charging the capacitor with a known current for a known period of time, measuring the resulting voltage, then calculating the capacitance. Capacitors larger than 100  $\mu$ F take several seconds to charge. The capacitor charge can be up to 3 V.

The meter's capacitance ranges are 1 nF, 10 nF, 100 nF, 1  $\mu$ F, 10  $\mu$ F, 100  $\mu$ F, 1 mF, 10 mF, and 50 mF.

To measure capacitance, set up the meter as shown in Figure 3-8. The blue key toggles the selection between capacitance and diode test.

While measuring capacitance, the following pushbutton functions are not available:

- Frequency (  )
- FAST MN MX (   )

The following are some tips for measuring capacitance:

- To speed up measurements of similar values, press  to manually select the proper range.
- To improve the measurement accuracy of small value capacitors, press  with the test leads open to subtract the residual capacitance of the meter and leads.



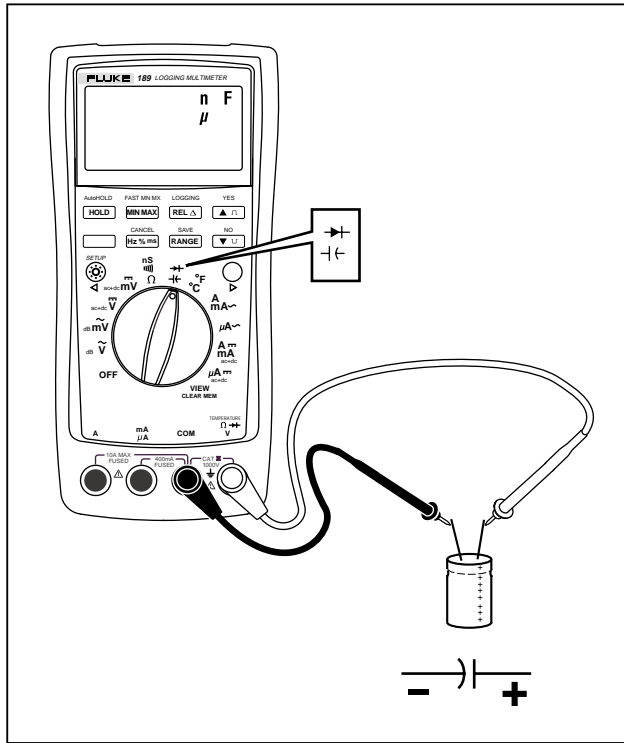

Figure 3-8. Capacitance Measurement

ach005f.eps

## Testing Diodes

### Caution

To avoid possible damage to the meter or to the equipment under test, disconnect circuit power and discharge all high-voltage capacitors before testing diodes.

Use the diode test to check diodes, transistors, silicon controlled rectifiers (SCRs), and other semiconductor devices. The test sends a current through a semiconductor junction, then measures the junction's voltage drop. A typical junction drops 0.5 V to 0.8 V. In diode test, the beeper is active. It beeps briefly for a normal junction and is on continuously if a short is detected.

To test a diode out of a circuit, set up the meter as shown in Figure 3-9.

In a circuit, a similar diode should still indicate a forward-bias reading of 0.5 V to 0.8 V; however, the reverse-bias reading can vary depending on the resistance of other pathways between the probe tips.

The blue key toggles between diode test and capacitance. Since diode test uses a fixed range, **RANGE** cannot be used.

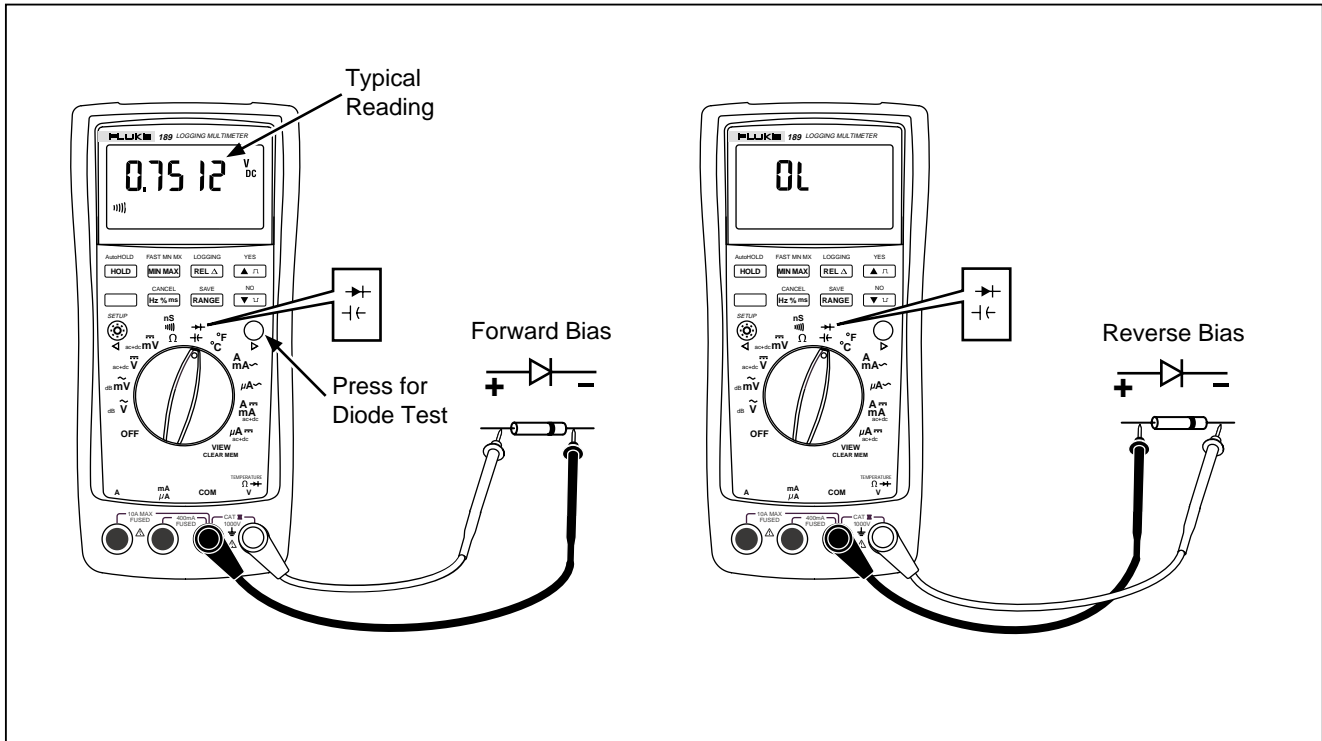

Figure 3-9. Diode Test

ach006f.eps

## Measuring Temperature

To measure temperature, set up the meter as shown in Figure 3-10. The meter begins temperature measurement in the degree units last used (Celsius °C or Fahrenheit °F). Once you have selected the temperature function, you can change units by pressing the blue button. The meter remembers the units selected until they are changed.

The primary display shows either the temperature or the message 'OPEN' (for an open thermocouple condition). Shorting the input will display the temperature at the meter terminals.

The secondary display shows any non-zero temperature offset. This offset is established as a calibrating value during setup. Refer to Chapter 5 for additional information.

The following pushbuttons cannot be used when taking temperature measurements:

- Frequency ( Hz % ms )
- FAST MN MX ( MIN MAX )
- Ranging ( RANGE )

### **Warning**

To avoid the potential for fire or electrical shock, do not connect the thermocouples to electrically live circuits.

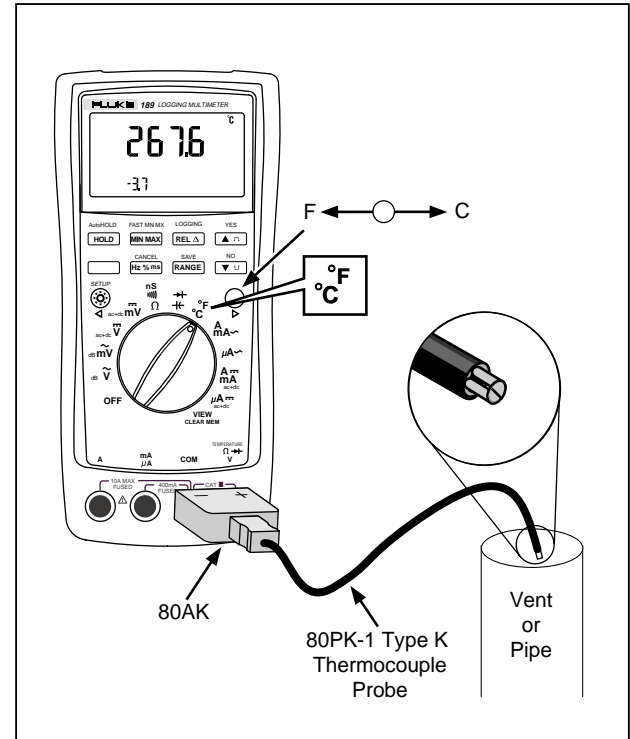

Figure 3-10. Temperature Measurement

ach010f.eps

## Measuring Current

### Warning

Never attempt an in-circuit current measurement where the open-circuit potential to earth is greater than 1000 V. You may damage the meter or be injured if the fuse blows during such a measurement.

### Caution

To avoid possible damage to the meter or to the equipment under test, check the meter's fuses before measuring current. Use the proper terminals, function, and range for your measurement. Never place the probes across (in parallel with) any circuit or component when the leads are plugged into the current terminals.

Current is the flow of electrons through a conductor. To measure current, you must open the circuit under test, then place the meter in series with the circuit.

To measure ac or dc current, proceed as follows:

1. Turn off power to the circuit. Discharge all high-voltage capacitors.
2. Insert the black lead into the **COM** terminal. Insert the red lead in an input appropriate for the measurement range as shown in Table 3-1.

### Note

To avoid blowing the meter's 440 mA fuse, use the **mA/μA** terminal only if you are sure the current is less than 400 mA.

Table 3-1. Current Measurement

Rotary Switch	Input	Ranges
$\overset{\text{A}}{\text{mA}} \sim$ or $\overset{\text{A}}{\text{mA}} \text{---}$ <small>ac+dc</small>	<b>A</b>	5.0000 A 10.000 A (reading flashes at 10 A, overloads (OL) at 20 A)
	<b>mA</b> <b>μA</b>	50.000 mA 500.00 mA
$\overset{\mu\text{A}}{\mu\text{A}} \sim$ or $\overset{\mu\text{A}}{\mu\text{A}} \text{---}$ <small>ac+dc</small>	<b>mA</b> <b>μA</b>	500.00 μA 5000.0 μA

3. If you are using the **A** terminal, set the rotary switch to mA/A. If you are using the **mA/μA** terminal, set the rotary switch to μA for currents below 5000 μA (5 mA), or mA/A for currents above 5000 μA.
4. Open the circuit path to be tested. Touch the red probe to the more positive side of the break; touch the black probe to the more negative side of the break. Reversing the leads will produce a negative reading, but will not damage the meter.
5. Turn on power to the circuit; then read the display. Be sure to note the unit given at the right side of the display (μA, mA, or A).
6. Turn off power to the circuit and discharge all high-voltage capacitors. Remove the meter and restore the circuit to normal operation.

### **Input Alert™ Feature**

If a test lead is plugged into the **mA/μA** or **A** terminal, but the rotary switch is not correctly set to one of the current measuring positions, the beeper warns you by making a chirping sound and the display shows "LEAD5".

This Input Alert warning is intended to stop you from attempting to measure voltage, continuity, resistance, capacitance, or diode values when the leads are plugged into a current terminal.

*Placing the probes across (in parallel with) a powered circuit when a lead is plugged into a current terminal can damage the circuit you are testing and blow the meter's fuse. This can happen because the resistance through the meter's current terminals is very low, so the meter acts like a short circuit.*

#### *Note*

*The beeper may sound in the presence of high electrical noise, such as that found near Pulse Width Modulation (PWM) motor drives.*

The following are some tips for measuring current:

- If the display shows **LEAD5** and you are sure the meter is set up correctly, test the meter's fuses as described under "Testing the Fuses" in Chapter 6.
- A current meter drops a small voltage across itself, which might affect circuit operation. You can calculate this burden voltage using the values listed in Chapter 7 under Burden Voltage (A, mA,  $\mu$ A).

### ***Measuring AC Current***

To measure ac current, set up the meter as shown in Figure 3-11.

The blue pushbutton cannot be used with ac current measurement. All other pushbutton features can be used.

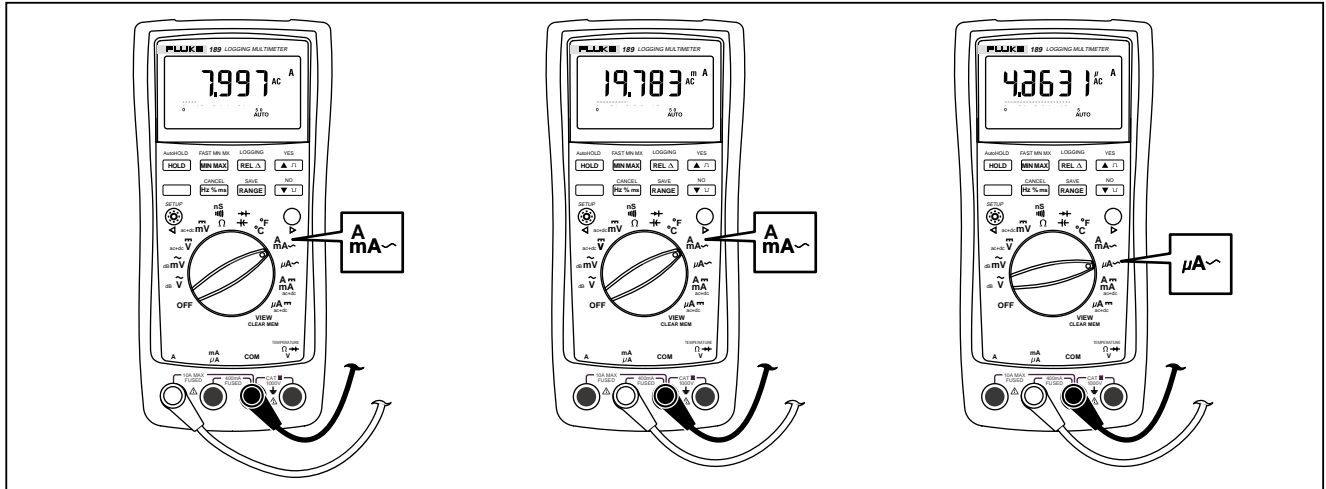

Figure 3-11. AC Current Measurement

ach008f.eps

## Model 187 & 189

### Users Manual

---

### Measuring DC Current

To measure dc current, set up the meter as shown in Figure 3-12.

You can view separate dc and ac amps signal components.

- Press  once to display ac current in the primary display and dc current in the secondary display (ac over dc).
- Press  a second time to reverse the displays (dc over ac).
- Press  a third time to display the ac + dc rms value in the primary display. (FAST MN MX is unavailable in this state.)
- Press  a fourth time to return to the normal dc display.

In either of these states, the following pushbutton functions are not available:

Display hold (  ).

AutoHOLD (   )

MIN MAX (  )

FAST MN MX (   )

Hz (  )

Relative (  )

LOGGING and SAVE (Model 189)



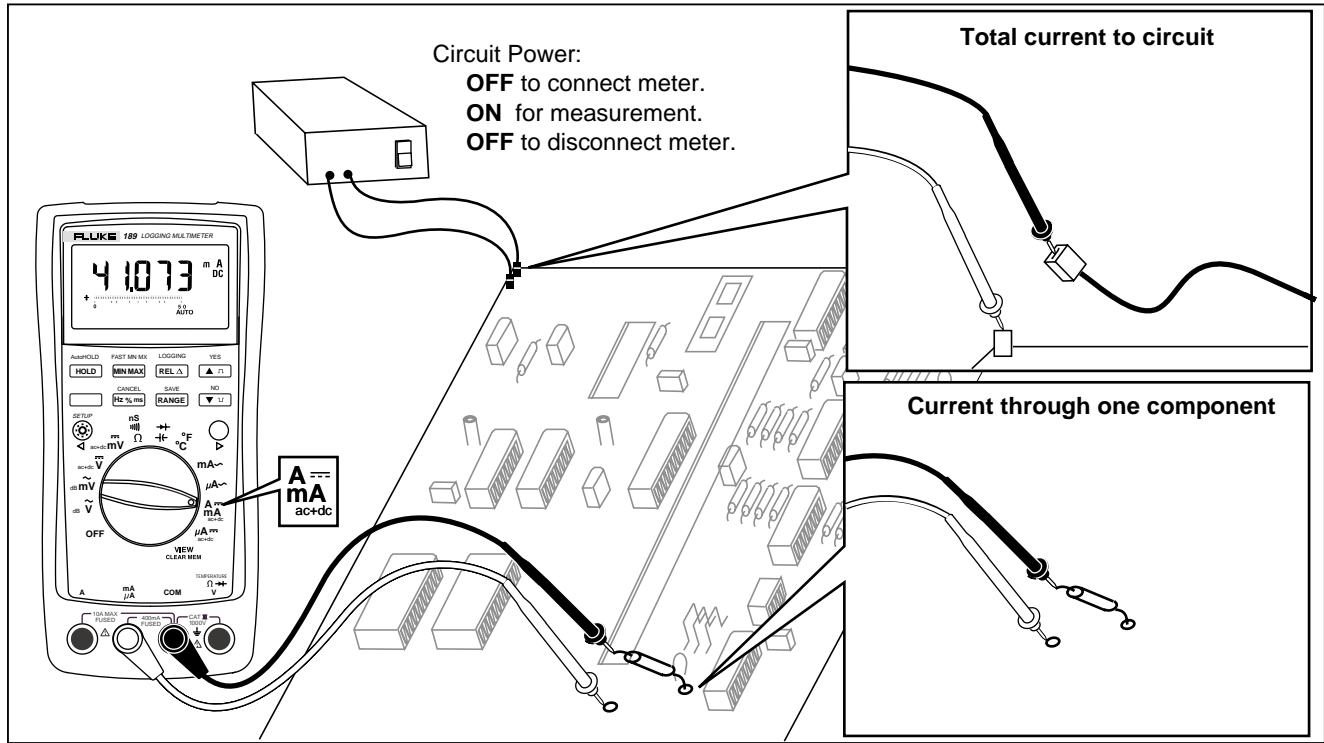

Figure 3-12. DC Current Measurement

ach007f.eps

## Measuring Frequency

Frequency is the number of cycles a signal completes each second. The meter measures the frequency of a voltage or current signal by counting the number of times the signal crosses a threshold level each second.

Figure 3-13 highlights the function selections that allow frequency measurement.

To measure frequency, select an appropriate function, connect the meter signal source, and press  $\overline{\text{Hz \% ms}}$ .

The meter autoranges to one of four frequency ranges: 500.00 Hz, 5.0000 kHz, 50.000 kHz, and 999.99 kHz. Figure 3-14 shows a typical frequency display.

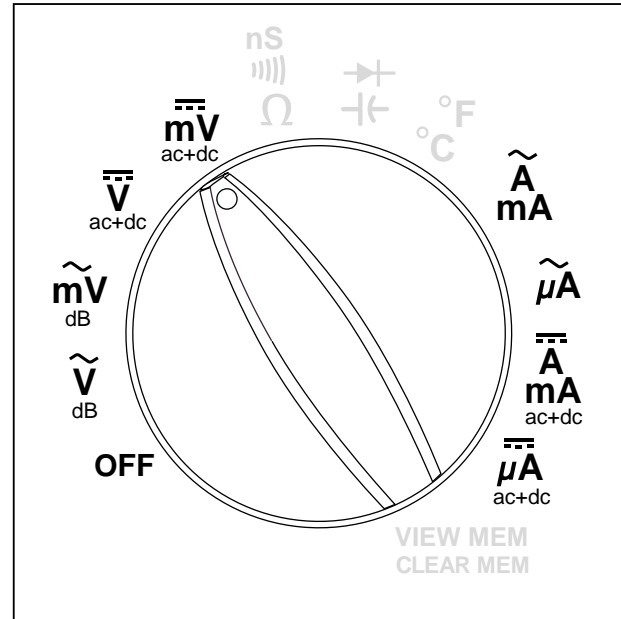
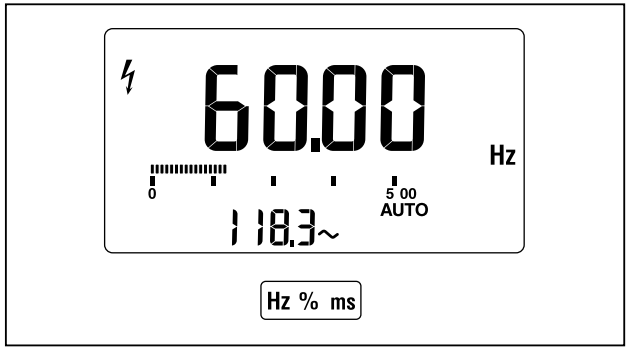

Figure 3-13. Functions Allowing Frequency Measurement

tc021f.eps



tc026f.eps

**Figure 3-14. Hz Display**

The meter beeps to indicate when a particular pushbutton is not allowed when measuring frequency. The following are some general rules.

- Relative (  ), Hold (  ), and MIN MAX (  ) can be used.
- FAST MN MX (   ) cannot be used.

The following are some tips for measuring frequency:

- If a reading shows as 0 Hz or is unstable, the input signal may be below or near the trigger level. You can usually correct these problems by selecting a lower range, which increases the sensitivity of the meter.
- If a reading seems to be a multiple of what you expect, the input signal may be distorted. Distortion can cause multiple triggerings of the frequency counter. Selecting a higher voltage range might solve this problem by decreasing the sensitivity of the meter. In general, the lowest frequency displayed is the correct one.

**Measuring Duty Cycle**

Duty cycle (or duty factor) is the percentage of time a signal is above or below a trigger level during one cycle (Figure 3-15).

The duty cycle mode is optimized for measuring the on or off time of logic and switching signals. Systems such as electronic fuel injection systems and switching power supplies are controlled by pulses of varying width, which can be checked by measuring duty cycle.

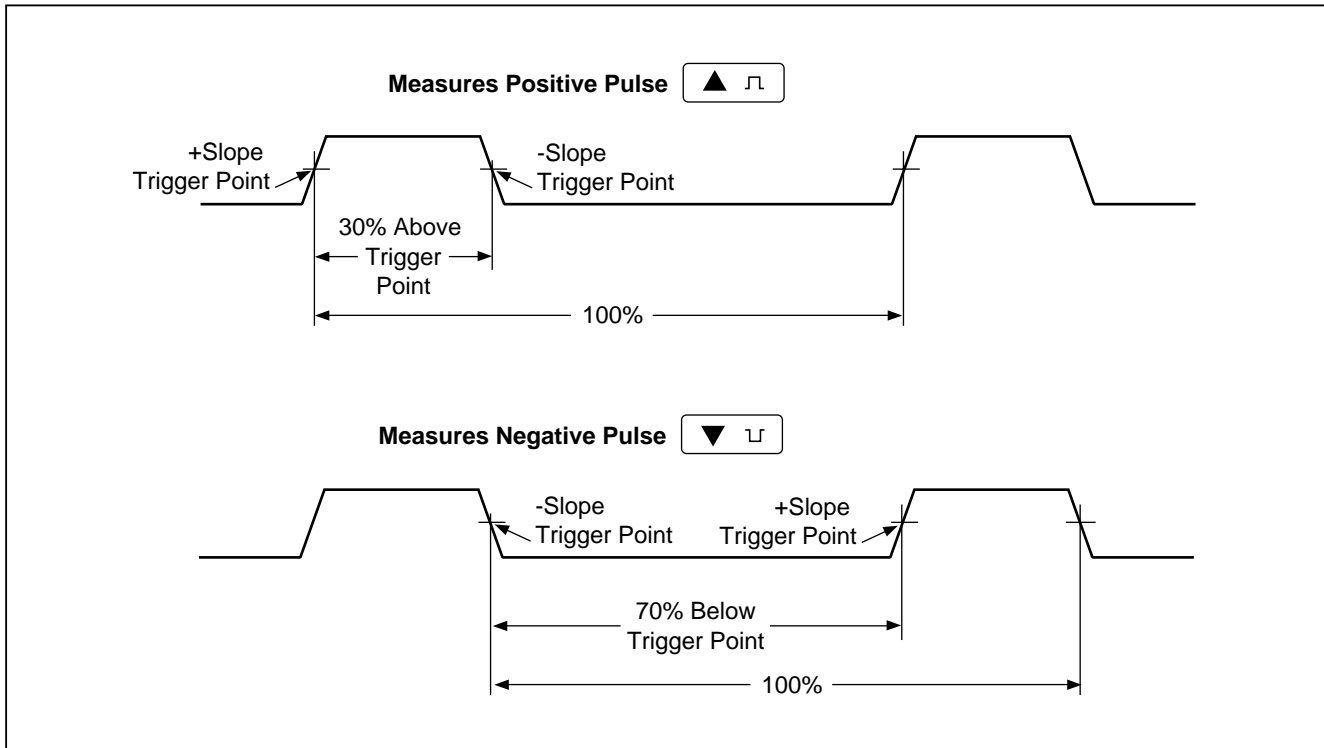
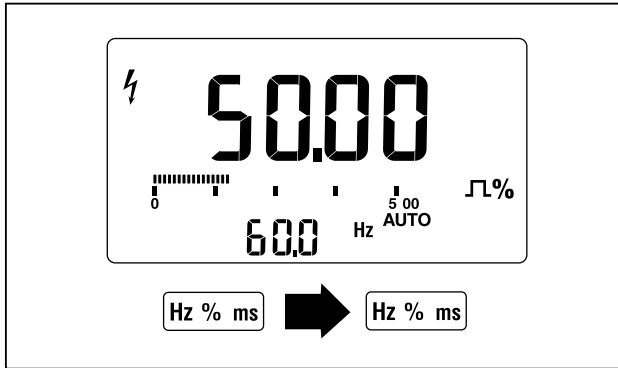

Figure 3-15. Duty Cycle Measurements

tc009f.eps

To measure duty cycle, set up the meter to measure frequency; then press **[Hz % ms]** a second time. You can select the level the meter uses by pressing **[Δ ▽]** to trigger on the positive slope or **[▽ ▽]** to trigger on the negative slope. A typical duty cycle display is shown in Figure 3-16.



tc027f.eps

**Figure 3-16. Duty Cycle Display**

For 5 V logic signals, use the 5 V dc range. For 12 V switching signals in automobiles, use the 50 V dc range. For sine waves, use the lowest ac or dc range that does not result in multiple triggering. A manually-selected lower

input range will often measure better than the AUTO-selected input range.

If a duty cycle reading is unstable, press **[MIN MAX]** until the AVG annunciator comes on and the average reading appears in the secondary display.

### **Measuring Pulse Width**

The pulse width function allows you to measure the amount of time a signal is high or low within a given period. See Figure 3-17. The measured waveform must be periodic; its pattern must repeat at equal time intervals.

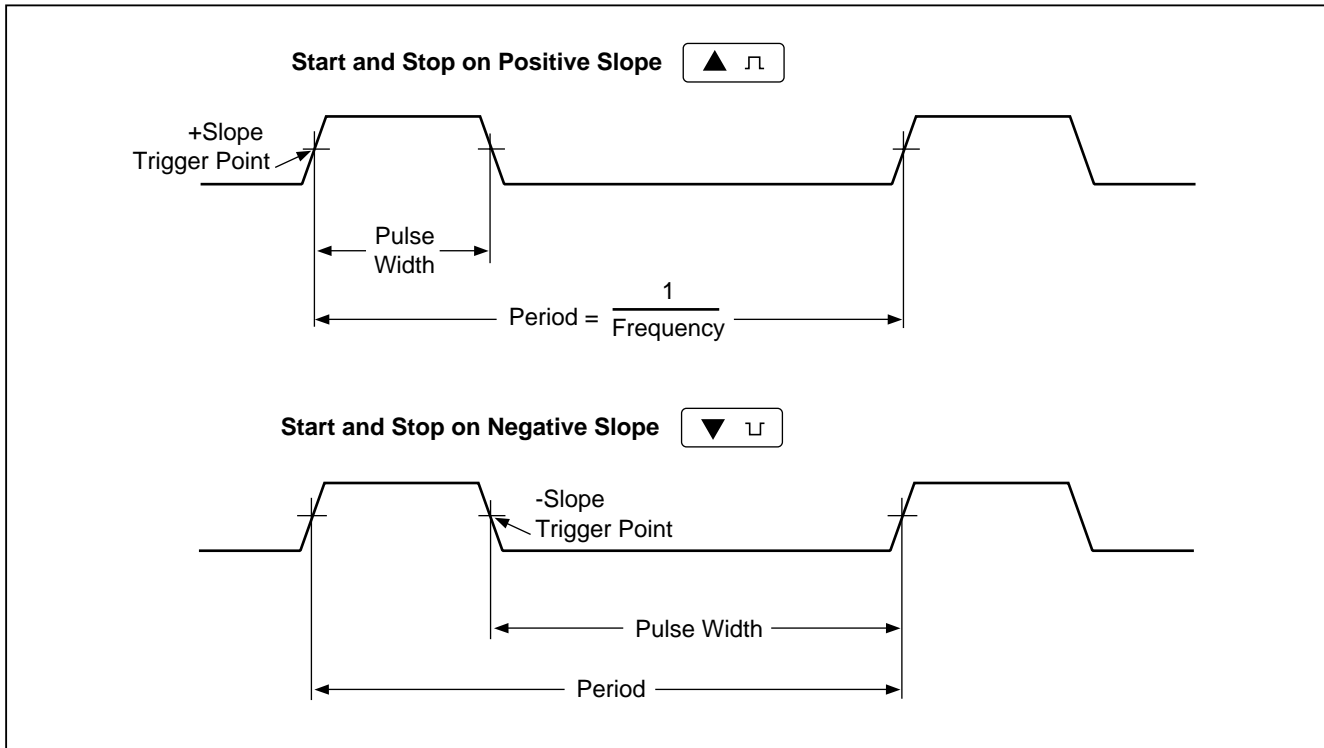

tc020f.eps

Figure 3-17. Pulse Width Measurements

The meter measures pulse width in the 500.00 or 1000.0 ms ranges.

To measure pulse width, set up the meter to measure frequency; then press **Hz % ms** two more times. As with the duty cycle function, you can select which level the meter uses by pressing **△ ▭** to trigger on the positive slope or **▽ ▭** to trigger on the negative slope. A typical pulse width display is shown in Figure 3-18.

You can improve pulse width stability by selecting the averaging feature. Press **MIN MAX** until “AVG” appears in the display.

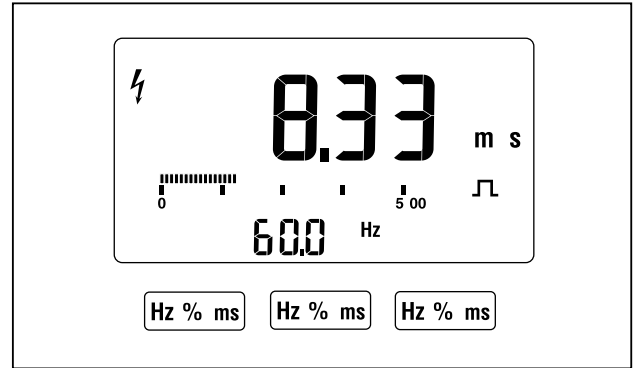

tc028f.eps

Figure 3-18. Pulse Width Display





# Chapter 4

## Using Memory & Communications Features

### Introduction

Chapter 4 shows you how to use memory and communication features available on the meters.

#### Note

*Memory, Logging, and Save features apply to the 189 only.*

### Types of Memory

The meter has two types of memory data: *saved readings* and *logged readings*.

#### Saved Readings Memory

Saved readings include primary and secondary readings and functions, the time stamp, and display icons representing various features in effect.

#### Logged Readings Memory

The logging interval (Log Int) can be set using the meter or *FlukeView Forms*. You can view the average reading for each logging interval on the meter's display. A scheduled logging interval may contain stable and unstable logged readings. Unstable logged readings represent unstable events as defined by the AutoHOLD function. See the Specifications.

To provide more detailed logging information, the meter also stores the high, low, and average value for each set of stable and unstable logged readings. You can only access these logged readings using *FlukeView Forms*.

Some of the logged readings can only be accessed using a PC running the *FlukeView Forms* software. *FlukeView Forms* displays the data in graphical or tabular form, prints, and stores the data.

## Storing Saved Readings

To add the current displayed reading to the saved readings memory, press  (SAVE).

- **SAVE d** appears briefly to confirm the operation and the index number display increments by one.
- **FULL** appears if no room is available in the saved readings memory (after 100 saves).

Saved readings can be viewed later as originally displayed. Actual primary and secondary readings and functions, the time stamp, and display icons are all stored in stored readings memory. (The meter does not save the bar graph.) For example, if the original reading was in volts ac function with the dB modifier selected, the saved reading will contain the saved dB value.

## Starting Logging

To begin logging, press  (LOGGING).

**LOG** is shown on the display. The logging interval is preset to 15 minutes.

To change the logging interval, see “Selecting Setup Options” in Chapter 5. The logging interval can be as high as 99 minutes or as low as 1 second. There is enough meter memory for at least 288 intervals (3 days of 15-minute intervals.) Use *FlukeView Forms* to store additional logging data in your PC's memory.

### Note

*The meter allows interval logging to begin only if logged readings memory is empty. Refer to the “Clearing Memory” discussion below.*

## Stopping Logging

Logging stops when one of the following occurs:

- You press  (CANCEL).
- A flashing low battery condition (**+ ■**) occurs.
- Logged readings memory becomes full.
- You change the rotary switch position.

## Viewing Memory Data

Use the following procedure to view memory data:

### Note





*Viewing memory data involves turning the rotary switch from its current function. Selections are not retained when you turn the switch. To return the meter to this function after viewing memory data, note the function and the enabled selections before you turn the rotary switch.*

1. Disconnect the input leads at the measurement source.

### Warning

**To avoid electric shock, disconnect the test leads at the measurement source prior to viewing memory data.**

2. Turn the rotary switch to the VIEW MEM position.

3. The primary display shows memory data. Refer to Figure 4-1 for an explanation of the VIEW MEM display.
4. If the primary display data is a logged reading, **LOG** appears in the display. You can switch between the two types of memory data.  
  
Press  (SAVE) for saved reading.  
  
Press  (LOGGING) for logged reading  
  
To view more detailed logged reading information, use *FlukeView Forms* software.
5. The index (lower left corner of the display) identifies the displayed memory data by number. You can view additional memory data by pressing  and .
6. Repeat steps 4 and 5 to switch between the two types of memory data.
7. To exit viewing memory, turn the rotary switch to any other position. Remember that the meter returns to the default selections for the new function position.

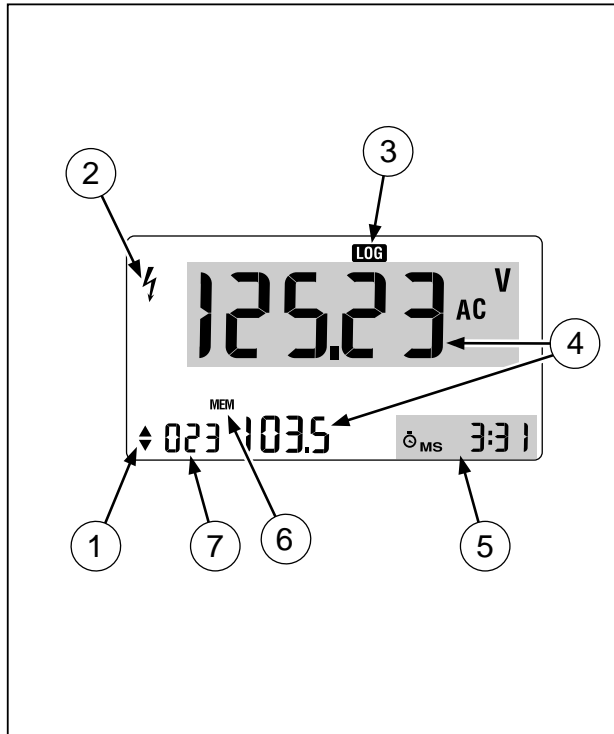

tc035f.eps

Figure 4-1. View Display

Table 4-1. View Display

No.	Item	Description
	↕ arrow icons.	Denotes use of $\boxed{\Delta}$ or $\boxed{\nabla}$ to select higher or lower index numbers.
	⚡ symbol	Hazardous voltage could be present at inputs.
	<b>LOG</b>	Identifies that the average of a logging interval is displayed. When off, a saved reading is displayed.
	Memory data	Shows logged readings or secondary readings.
	Time display	Indicates a time stamp (⌚ off) or elapsed time (⌚ on) display.
	MEM	On during View memory.
	Index number	Identifies the data entry being viewed.

## Clearing Memory

You can clear memory in two ways.

- First, If the rotary switch is in the VIEW MEM position, you can press the blue button (○) to activate the CLEAR MEM function. [ L r. ] appears in the display.

You are then prompted to press  (YES) to clear the type of memory presently in use or  (NO) to stop the clear procedure. The display defines the type of memory to be cleared, as:

**LOG** to clear logged readings memory.

**MEM** to clear saved readings memory.

- A second clearing procedure is required when you try to start logging and the logged readings memory is not empty.

[ L r. ] appears in the display. To clear the logged readings memory and begin logging new data, Press  (YES).

To decline the clearing operation and not begin logging, press  (NO).

If you attempt to save a meter reading when saved readings memory is full, FULL appears in the display. You must use the VIEW MEM function to clear saved readings memory before proceeding.

## Using Communications (187 and 189)

When using a PC-to-meter IR (infrared) communication link, refer to the *FlukeView Forms Installation Guide* or the on-line help.

You can use the IR communication link and *FlukeView Forms* software to transfer the contents of a meter's memory to a PC.

### Note

*The 187 and 189 will log in real time mode to a connected computer running FlukeView Forms.*

*In addition, the 189 allows the user to log to internal memory and connect to the computer later for download.*

*FlukeView Forms* allows you to place the data into standard (default) or customized forms. The forms can display the data in table and graph form, as well as view user comments. You can use these forms to satisfy ISO-9000 and other documentation requirements.



# Chapter 5

## Changing the Default Settings

### Introduction

The meter allows you to change the default operating configuration of the meter by changing setup options made at the factory.

Many of these setup options affect general meter operations and are active in all functions. Others are limited to one function or group of functions.

These settings are stored and can be changed in the Setup mode using the procedure described in this chapter.

### Selecting Setup Options

To enter the Setup mode, turn the meter on and press   (SETUP).

In the Setup mode, each press of   (SETUP) saves changes to the last selection and steps to the next option.

Each setup option appears in the primary display in the sequence shown in Tables 5-1 and 5-2.

The options in Table 5-1 are available only when the preconditions are met. The options in Table 5-2 are available for all functions. (When measuring dc volts, none of the preconditions in Table 5-1 are required, and only the selections shown in Table 5-2 will appear.)

To exit the Setup mode, Press  Hz % ms (CANCEL). Be sure to save your last selection by pressing   first.)

**Table 5-1. Function Specific Setup Selections**









<b>Selection</b>	<b>Precondition</b>	<b>Option</b>	<b>Choices ( ◀ ▶ )</b>	<b>Factory Default</b>
0000.0 °C or 0000.0 °F	Temperature ( °C <sup>F</sup> ) selected.	Temperature offset adjust	0000.0 ° to ±1000.0 °C ( 1800.0 °F ) - Use $\blacklozenge$ to increment or decrement digit.  Use ◀ ▶ to select digit. Selected digit flashes.	0000.0 °C ( or °F )
Log Int	Model 189 only.	Log interval	MM:SS - Use $\blacklozenge$ to increment or decrement minute or second values.  Use ◀ ▶ to select minute or seconds. Selected values flash.	15:00
dB REF	AC volts ( $\tilde{V}$ or $\tilde{mV}$ ) selected.	dB type	dBm or dBV ( m or V flashing ) - Use ◀ ▶ to select.	dBV
dB REF	AC volts ( $\tilde{V}$ or $\tilde{mV}$ ) and dBm selected.	dBm reference	0001 $\Omega$ to 1999 $\Omega$ - Use $\blacklozenge$ to increment or decrement digit.  Use ◀ ▶ to select digit.	0600 $\Omega$



**Table 5-2. Common Setup Selections**

<b>Selection</b>	<b>Option</b>	<b>Choices</b>	<b>Factory Default</b>
bEEP	Beeper	YES or NO (flashing) Use ◀ ▶ to select.	YES
BBBB	Display digits	BBBB (4) or BBBBBB (5) Use ◀ ▶ to select.	BBBBB
BL OFF	Backlight time out	MM:SS - Use ⬆ to increment or decrement minute or second values.  Use ◀ ▶ to select minutes or seconds. Selected values flash. Setting value to 00:00 disables timeout.	15:00
Pr OFF	Power off time out	HH:MM - Use ⬆ to increment or decrement hour or minute values.  Use ◀ ▶ to select hours or minutes. Selected values flash.	00:15
Hour	24-hour clock	HH:MM - Use ⬆ to increment or decrement hour or minute values.  Use ◀ ▶ to select hours or minutes. Selected values flash.	00:00
50-60	Line/Main frequency	60 or 50 (flashing) - Use ◀ ▶ to select.	60
Fc t Y	Restore factory defaults	YES or NO (flashing) - Use ◀ ▶ to select.	NO

Select and edit setup options as follows:

- Turn the rotary switch to a measurement function:
- Press   to advance to the next setup option and save the present selection.
- Press   to increase or   to decrease a value.
- Press  () to go back to the previous digit or selection.
- Press  () to advance to the next digit or selection.
- Any digit or selection being changed flashes when active.
- Press   Hz % ms (CANCEL) to exit Setup. (Be sure to save your last selection by pressing   first.)

## ***Adjusting the Temperature Offset***

If the meter is in a temperature measurement function, use the following procedure to set an offset for your temperature probe:

1. Turn the rotary switch to temperature ( $^{\circ}\text{C}$  or  $^{\circ}\text{F}$ ).
2. Connect the temperature probe and probe adapter to the **COM** and **V** inputs on the meter.
3. Place the temperature probe and an accurate thermometer in a lag bath (i.e., a container with an isothermal liquid).
4. Press   to enter the Setup mode and temperature adjust.

The primary display shows the measured value for the temperature probe. This value is already adjusted by any previously stored offset (shown in the secondary display.) See Figure 5-1.

If necessary, adjust the temperature offset until the temperature on the primary display matches the temperature indicated by the lag bath thermometer.

1. Press  () to advance to the next digit and press  () to go back to the previous digit.
2. Press   or   to increase or decrease the digit value.
3. Save changes by pressing  .
4. Press   to exit Setup.

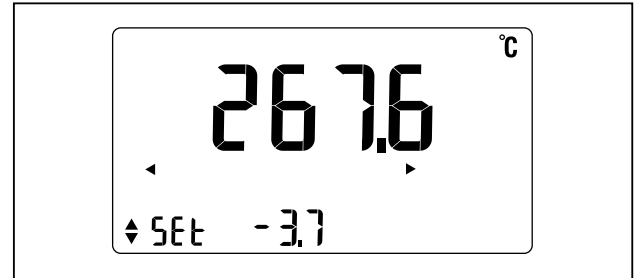

tc041f.eps





**Figure 5-1. Adjusting Temperature Offset**

## **Selecting Display Resolution (3 1/2 or 4 1/2 Digits)**

For most functions, you can choose whether the meter displays the reading in 3-1/2 or 4-1/2 digits.

- The 3-1/2 digit setting provides lower resolution with faster response time.
- The 4-1/2 digit setting provides greater resolution with slower response time. The 4-1/2 digit display is available with all functions except continuity, conductance, capacitance, and FAST MN MX.





To select the display resolution:

1. Press , then  until **0000** (for 3-1/2 digits) or **00000** (for 4-1/2 digits) appears in the display.
2. To change the selection, press  (<) or  (>).
3. Press , then  to save the selection and proceed to the next setup selection.

## **Setting the Power Off Timeout**

1. Press   until **P r OFF** appears in the display.

The present power off time in hours and minutes appears as four digits in the lower right corner of the display. The maximum timeout setting is 23 hours and 59 minutes. The minimum setting (00:00) disables the power off timeout.

2. Press  (to advance) or  (to go back) between digits.
3. With the desired digit selected (flashing), press   (to increment) or   (to decrement) the value.
4. When you have set the digits as desired, press   to save the settings and proceed to the next setup selection.

## Setting the 24-Hour Clock



The meter uses 24-hour clock readings as time stamps during HOLD, AutoHOLD, MIN MAX, FAST MN MX, SAVE, and LOGGING operations.





Hours and minutes to a maximum of 23:59 can be set.

### Note

*The meter uses elapsed time for all MIN MAX readings. Elapsed time is expressed in minutes and seconds to a maximum of 59:59 and then changes to hours and minutes.*

To change the 24-hour clock:





1. Press   until Hour appears in the display and the hour digits in the lower right corner of the display begin flashing.
2. Press   or   to increase or decrease the hour value.

3. Press   to advance to the minute setting; the minute digits begin flashing.
4. Press   or   to increase or decrease the minute value.
5. Press   to store the selection and proceed to the next selection.

## Setting the Line (Main) Frequency



Although the meter operates on battery power only, it is important to specify the frequency (50 or 60 Hz) of the line (main) power. This allows the meter to filter out related noise.

To change the line (main) frequency:

1. Press   until 50-60 appears in the display.
2. Press  or   to change the selection to the correct frequency.
3. Press   to store the selection and proceed to the next selection.

## **Returning to Factory Defaults**

Your meter comes with the setup options preset at the factory. These factory settings are shown in Tables 5-1 and 5-2. You can always return to these settings as follows:

1. Press   until **FctY** appears in the display.
2. Press  to select **YES**; press  to select **no**.

If you select **YES**, all setup options revert to the factory defaults; you cannot specify individual choices.

3. Press   to exit the setup procedure and activate your selection.

If you selected **YES** in step 2, all factory settings are restored.

If you selected **no**, selections made in the Setup mode become active.

## **Saving Setup Options**

At each setup option, store your choice and advance to the next option by pressing  .

If you are storing the last option, this also exits the setup mode.

To exit the Setup mode without saving the present option, press  **Hz % ms** (CANCEL).

Selections that were previously saved with   are retained.

# Chapter 6

## Maintenance

### Introduction

This chapter describes basic operator maintenance. For calibration and performance test information, order the *187 & 189 Service Manual*, PN 1584337.

### General Maintenance

Periodically wipe the case with a damp cloth and mild detergent. Do not use abrasives or solvents.

Dirt or moisture in the terminals can affect readings and can falsely activate the Input Alert feature. Clean the terminals as follows:

1. Turn the meter off and remove all test leads.
2. Shake out any dirt that may be in the terminals.

3. Soak a new swab with alcohol. Work the swab around in each terminal.

### Testing the Fuses

Before measuring current, test the appropriate fuse as shown in Figure 6-1. If the tests give readings other than those shown, have the meter serviced.

#### Warning

**To avoid electrical shock or personal injury, remove the test leads and any input signals before replacing the battery or fuses. To prevent damage or injury, install ONLY specified replacement fuses with the amperage, voltage, and speed ratings shown in Chapter 7.**

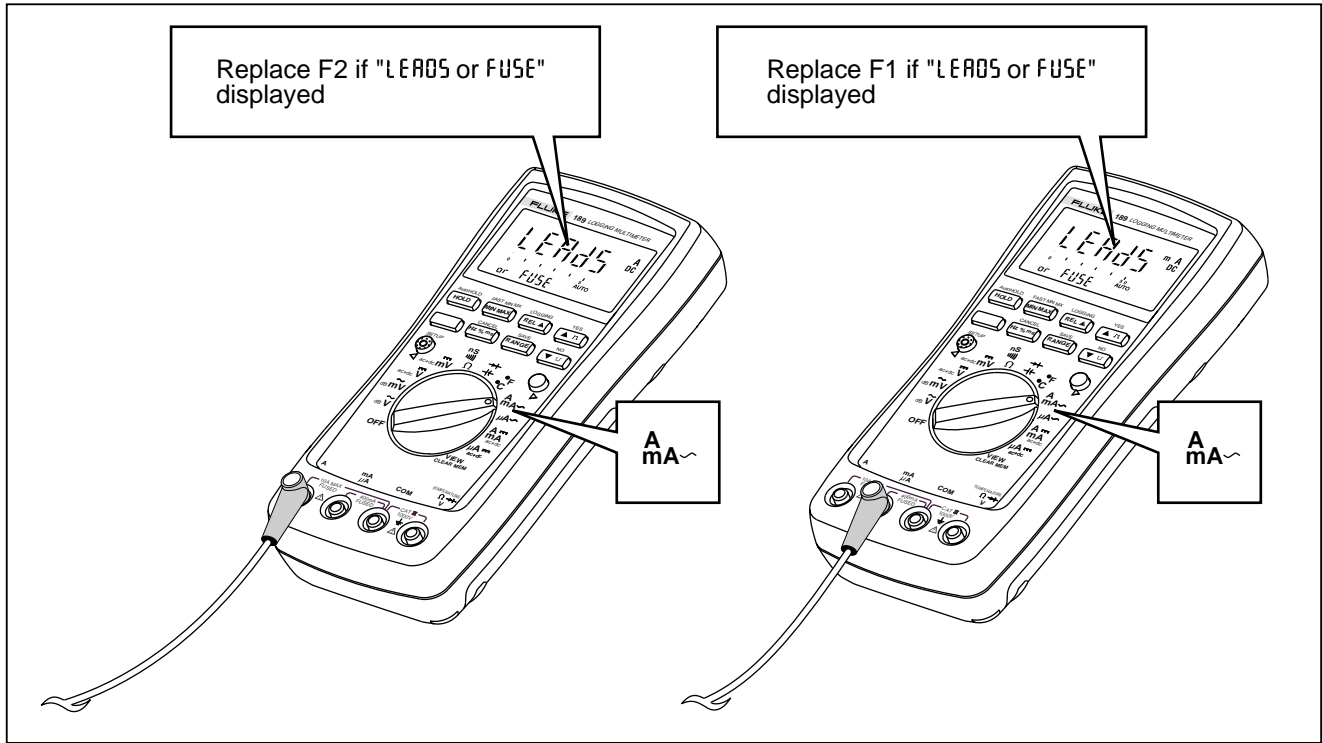

Figure 6-1. Testing the Current Fuses

ach038f.eps



## **Replacing the Batteries**

Replace the batteries with four AA batteries (NEDA I5A or IEC LR6).

### **Warning**

**To avoid false readings, which could lead to possible electric shock or personal injury, replace the batteries as soon as the battery indicator (  ) appears.**

Replace the batteries as follows (refer to Figure 6-2):

1. Turn the rotary switch to OFF and remove the test leads from the terminals.
2. Remove the battery door by using a standard-blade screwdriver to turn the battery door screws one-quarter turn counterclockwise.
3. Replace the batteries and the battery door. Secure the door by turning the screws one-quarter turn clockwise.

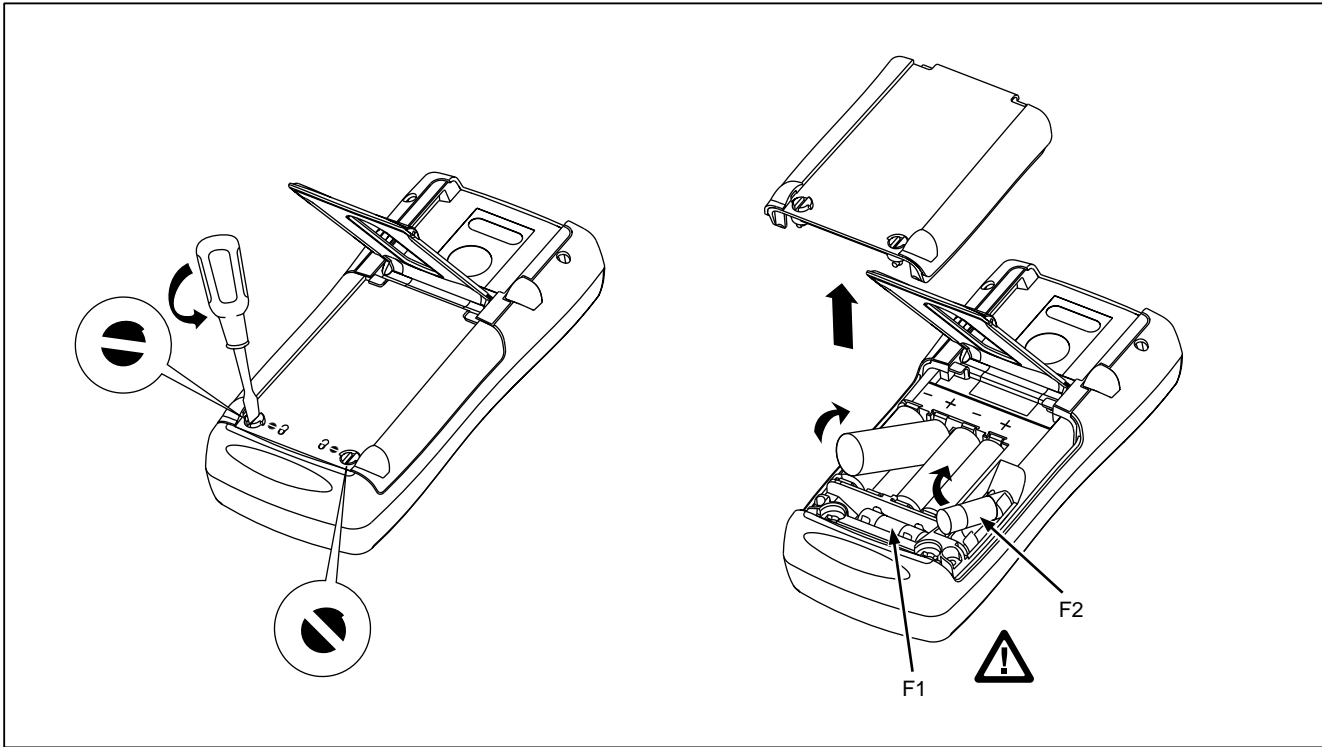

**Figure 6-2. Battery and Fuse Replacement**

tc037f.eps

## Replacing the Fuses

### Warning

**To avoid electrical shock or damage to the meter, only use replacement fuses specified in Table 6-1.**

Referring to Figure 6-2, examine or replace the meter's fuses as follows:

1. Turn the rotary switch to OFF and remove the test leads from the terminals.
2. Remove the battery access door by using a standard-blade screwdriver to turn the battery door screws one-quarter turn counterclockwise.
3. Remove either fuse by gently prying one end loose, then sliding the fuse out of its bracket.
4. Install **ONLY** specified replacement fuses with the amperage, voltage, and speed ratings shown in Chapter 7.
5. Reinstall the battery door. Secure the door by turning the screws one-quarter turn clockwise.

## User-Replaceable Parts

User-replaceable parts are listed in Table 6-1. These parts can be ordered by contacting Fluke. See "How to Contact Fluke" in Chapter 1.

## In Case of Difficulty

If the meter does not seem to work properly:

1. Examine the case for damage. If damage is detected, contact Fluke. See "Contacting Fluke" in Chapter 1.
2. Check and replace (as needed) the batteries, fuses, and test leads.
3. Review this manual to verify correct operation.
4. If the meter still does not work, pack it securely and forward it, postage paid, to the location provided by the appropriate Fluke contact. Include a description of the problem. Fluke assumes no responsibility for damage in transit.

A meter under warranty will be repaired or replaced (at Fluke's option) and returned at no charge. See the registration card for warranty terms.

**Model 187 & 189***Users Manual***Table 6-1. User-Replaceable Parts**

<b>Description</b>	<b>Reference Designators</b>	<b>Part Number</b>	<b>Qty</b>
Access Door, Battery / Fuse	MP14	666446	1
Tilt-Stand	MP8	659026	1
Accessory Mount	MP9	658424	1
⚠ Fuse, 0.44 A (44/100 A, 440 mA), 1000 V, FAST	F1	943121	1
⚠ Fuse, 11 A, 1000 V FAST	F2	803293	1
Battery, 1.5 V, 0-15 mA, AA Alkaline	H8, H9, H10, H11	376756	4
Fasteners, Battery / Fuse Access Door	H12, H13	948609	2
Screws, Phillip-Head	H4, H5, H6, H7	832246	4
AC70A Alligator Clip (Black)	MP38	738047	1
AC70A Alligator Clip (Red)	MP39	738120	1
TL71 Right-Angle Test Lead Set	MP34	802980	1
Getting Started Manual	(TM1-TM5)	(see footnote)	5
CD-ROM (Contains Users Manual)	(TM6)	1576992	1
Getting Started Manual PNs: English=1547486; French, German, Italian, Dutch=1555282; Danish, Finnish, Norwegian, Swedish=1555307; French, Spanish, Portuguese=1555294; Simplified Chinese, Traditional Chinese, Korean, Japanese, Thai=1555282			

# Chapter 7 Specifications

## Safety and Compliances

<b>Maximum voltage between any terminal and earth ground.</b>	1000 V dc or rms ac
<b>Compliances - DUAL RATINGS</b>	Complies with IEC 1010-1 to 1000 V Overvoltage Category III, Pollution Degree 2; and IEC 664-1 to 600 V Overvoltage Category IV, Pollution Degree 2 *
<b>Certifications (listed and pending)</b>	CSA per standard CSA/CAN C22.2 No. 1010.1-92 UL per standard UL 3111 TÜV per standard EN 61010 Part 1-1993
<b>Surge Protection</b>	8 kV peak per IEC 1010.1-92
<b>⚠ Fuse Protection for mA or <math>\mu</math>A inputs</b>	0.44 A (44/100 A, 440 mA), 1000 V FAST Fuse
<b>⚠ Fuse Protection for A input</b>	11 A, 1000 V FAST Fuse
<b>Markings</b>	C $\text{\textcircled{C}}$ , $\text{\textcircled{UL}}$ , and TÜV
<p>* OVERVOLTAGE (Installation) Categories refer to the level of Impulse Withstand Voltage protection provided at the specified Pollution Degree.</p> <ul style="list-style-type: none"> <li>• Overvoltage Category III equipment is equipment in fixed installations. Examples include switch gear and polyphase motors.</li> <li>• Overvoltage Category IV equipment is equipment for use at the origin of the installation. Examples include electricity meter and primary over-current protection equipment.</li> </ul>	

**Physical Specifications**

<b>Display (LCD)</b>	Digital: 50000/5000 counts primary display, 5000 counts secondary display; updates 4/second.  Analog: 51 segments, updates 40/second.
<b>Operating Temperature</b>	– 20 °C to + 55 °C
<b>Storage Temperature</b>	– 40 °C to + 60 °C
<b>Temperature Coefficient</b>	0.05 x (specified accuracy) / °C (<18 °C or >28 °C)
<b>Relative Humidity</b>	0 % to 90 % (0 °C to 35 °C) 0 % to 70 % (35 °C to 55 °C)
<b>Altitude</b>	Operating: 0-2000 meters per EN61010 CAT III, 1000 V; CAT IV, 600 V 0-3000 meters per EN61010 CAT II, 1000 V; EN61010 CAT III, 600 V; CAT IV, 300 V Storage: 10000 meters
<b>Battery Type</b>	4 AA Alkaline, NEDA 15A or LR6
<b>Battery Life</b>	72 Hours typical (with backlight off)
<b>Shock Vibration</b>	Per MIL-T-PRF 28800 for Class II instruments
<b>Electromagnetic Compatibility (EMC)</b>	Susceptibility and Emissions: Commercial Limits per EN61326-1
<b>Size</b>	10.0 cm x 20.3 cm x 5.0 cm (3.94 in x 8.00 in x 1.97 in) (Not Including Accessory Mount)
<b>Weight</b>	545 grams (1.2 lbs.)
<b>Case Sealing</b>	IP-42 per IEC 529, Section 3
<b>Warranty</b>	Lifetime
<b>Calibration Interval</b>	1 year

## Feature Summary

Feature	Description
<b>Dual Digital Displays</b>	Primary: 50,000 counts Secondary: 5,000 count
<b>Analog Bar Graph</b>	Bar graph: 51 segments, updates 40 times/second
<b>Backlight with 2 brightness levels</b>	Bright white backlight for clear readings in poorly lighted areas
<b>Fast Autorange</b>	Meter automatically selects best range - instantly
<b>AC+DC true rms, ac rms specified to 100 kHz</b>	Choices for AC only, AC and DC dual display, or AC+DC readings
<b>dBm, dBV</b>	User selectable impedance references for dBm
<b>AutoHOLD</b>	Holds readings on display
<b>Continuity / Open test</b>	Beeper sounds for resistance readings below threshold, or to indicate a momentary open circuit
<b>Fast Bar Graph</b>	51 segments for peaking and nulling
<b>Duty cycle / Pulse width</b>	Measure signal on or off time in % or milliseconds
<b>MIN MAX Mode</b>	Record maximum, minimum, and average values. 24-hour clock for MAX or MIN, elapsed time for AVG.
<b>FAST MN MX with 24-hour time stamp</b>	FAST MN MX captures peaks to 250 $\mu$ sec.
<b>Closed-Case Calibration</b>	No internal adjustments needed
<b>Battery / Fuse Access Door</b>	Battery or fuse replaceable without voiding calibration
<b>Hi-Impact Overmolded Case</b>	Protective holster features

## Basic Specifications

Function	Ranges/Description
DC Voltage	0 to 1000 V
AC Voltage, true RMS	2.5 mV to 1000 V – 100 kHz bandwidth
Basic Accuracy	DC voltage: 0.025 % AC voltage: 0.4 %
DC Current	0 to 10 A (20 A for 30 seconds)
AC Current, true RMS	25 $\mu$ A to 10 A (20 A for 30 seconds)
Resistance	0 to 500 M $\Omega$
Conductance	0 to 500 nS
Capacitance	0.001 nF to 50 mF
Diode Test	3.1 V
Temperature	-200 °C to 1350 °C (-328 °F to 2462 °F)
Frequency	0.5 Hz to 1000 kHz
LOGGING Intervals (Model 189 only)	At least 288 intervals may be stored. Up to 707 unstable event values (see AutoHold) are automatically added to LOGGING memory for viewing only through optional PC software. Additional intervals will be logged up to 995 if the signal is stable.
SAVE Readings (Model 189 only)	Up to 100 readings may be saved by the user in a memory separate from LOGGING memory. These readings may be viewed using VIEW MEM.



### Detailed Accuracy Specifications

Accuracy is specified for a period of one year after calibration, at 18 °C to 28 °C (64 °F to 82 °F), with relative humidity to 90 %. Accuracy specifications are given as:

$$\pm ( [\% \text{ of reading} ] + [ \text{number of least significant digits} ] )$$

AC mV, AC V, AC  $\mu$ A, AC mA, and AC A specifications are ac coupled, true rms and are valid from 5 % of range to 100 % of range. AC crest factor can be up to 3.0 at full-scale, 6.0 at half-scale except the 3000 mV and 1000 V ranges where it is 1.5 at full scale, 3.0 at half-scale.

Function	Range	Resolution	Accuracy				
			45 Hz-1 kHz	20-45 Hz	1 kHz-10 kHz	10 kHz-20 kHz	20 kHz-100 kHz
AC mV <sup>1,2</sup>	50.000 mV	0.001 mV	0.4 % + 40	2 % + 80	5 % + 40	5.5 % + 40	15 % + 40
	500.00 mV	0.01 mV	0.4 % + 40	2 % + 80	5 % + 40	5.5 % + 40	8 % + 40
	3000.0 mV	0.1 mV	0.4 % + 40	2 % + 80	0.4 % + 40	1.5 % + 40	8 % + 40
AC V <sup>1,2</sup>	5.0000 V	0.0001 V	0.4 % + 40	2 % + 80	0.4 % + 40	1.5 % + 40	8 % + 40
	50.000 V	0.001 V	0.4 % + 40	2 % + 80	0.4 % + 40	1.5 % + 40	8 % + 40
	500.00 V	0.01 V	0.4 % + 40	2 % + 80	0.4 % + 40	Not specified	Not specified
	1000.0 V	0.1 V	0.4 % + 40	2 % + 80	0.4 % + 40	Not specified	Not specified
dBV	-52 to -6	0.01 dB	0.1 dB	0.2 dB	0.5 dB	0.5 dB	1.4 dB
	-6 to +34	0.01 dB	0.1 dB	0.2 dB	0.1 dB	0.2 dB	0.8 dB
	+34 to +60	0.01 dB	0.1 dB	0.2 dB	0.1 dB	Not specified	Not specified

1. For the 5,000 count mode, divide the number of least significant digits (counts) by 10.
2. A residual reading of 8 to 180 digits with leads shorted, will not affect stated accuracy above 5 % of range.

**Model 187 & 189***Users Manual*

Function	Range	Resolution	Accuracy			
			45-1 kHz	20-45 Hz	1-20 kHz	20 kHz-100 kHz
AC $\mu$ A	500.00 $\mu$ A	0.01 $\mu$ A	0.75 % + 20	1 % + 20	0.75 % + 20	6 % + 40
	5,000.0 $\mu$ A	0.1 $\mu$ A	0.75 % + 5	1% + 5	0.75 % + 10	2 % + 40
AC mA	50.000 mA	0.001 mA	0.75 % + 20	1% + 20	0.75 % + 20	9 % + 40
	400.00 mA	0.01 mA	0.75 % + 5	1% + 5	1.5 % + 10	4 % + 40
AC A	5.0000 A	0.0001 A	1.5 % + 20	1.5% + 20	6 % + 40	Not specified
	10.000 A <sup>1</sup>	0.001 A	1.5 % + 5	1.5% + 5	5 % + 10	Not specified

1. 10 A continuous up to 35 °C, less than 10 minutes 35 °C to 55 °C. 20 A overload for 30 seconds maximum.

Function	Range	Resolution	Accuracy	Accuracy Dual Display AC or AC+DC <sup>3</sup>		
			DC	20 - 45 Hz	45 Hz - 1 kHz	1 kHz- 20 kHz
DC mV	50.000 mV	0.001 mV	0.1% + 20	2 % + 80	0.5 % + 40	6 % + 40
	500.00 mV	0.01 mV	0.03 % + 2			2 % + 40
	3000.0 mV	0.1 mV	0.025 % + 5			
DC V	5.0000 V	0.0001 V	0.025 % + 10 <sup>2</sup>	1 % + 20	1.0 % + 20	2 % + 40
	50.000 V	0.001 V	0.03 % + 3 <sup>2</sup>			
	500.00 V	0.01 V	0.1 % + 2 <sup>2</sup>			Not specified
	1000.0 V	0.1 V	0.1 % + 2 <sup>2</sup>			Not specified
DC μA	500.00 μA	0.01 μA	0.25 % + 20	1 % + 10	0.75 % + 10	2 % + 40
	5,000.0 μA	0.1 μA	0.25 % + 2	1 % + 20	0.75 % + 20	2 % + 40
DC mA	50.000 mA	0.001 mA	0.15 % + 10	1 % + 10	1 % + 10	3 % + 40
	400.00 mA	0.01 mA	0.15 % + 2	2 % + 20	2 % + 20	6 % + 40
DC A	5.0000 A	0.0001 A	0.5 %+ 10	1.5 % + 10	1.5 % + 10	5 % + 10
	10.000 A <sup>1</sup>	0.001 A	0.5 %+ 2			

1. 10 A continuous up to 35 °C, less than 10 minutes 35 °C to 55 °C. 20 A overload for 30 seconds maximum.

2. 20 counts in dual display DC or AC+DC.

3. See AC conversions notes for AC mV and V

**Model 187 & 189***Users Manual*

Function	Range	Resolution	Accuracy
Resistance <sup>1</sup>	500.00 Ω	0.01 Ω	0.05 % + 10 <sup>3</sup>
	5.0000 kΩ	0.0001 kΩ	0.05 % + 2
	50.000 kΩ	0.001 kΩ	0.05 % + 2
	500.00 kΩ	0.01 kΩ	0.05 % + 2
	5.0000 MΩ	0.0001 MΩ	0.15 % + 4 <sup>2</sup>
	30.000 MΩ	0.001 MΩ	1 % + 4 <sup>2</sup>
	100.0 MΩ	0.1 MΩ	3 % + 2 <sup>4</sup>
	500.0 MΩ	0.1 MΩ	10 % + 2 <sup>4</sup>
Conductance	50.00 nS	0.01 nS	1 % + 10

1. For the 5,000 count mode, divide the number of least significant digits (counts) by 10.
2. For relative humidity greater than 70 %, resistance accuracy is 0.5 % over 1 MΩ and 2.5 % over 10 MΩ.
3. Using relative mode (**REL Δ**) to zero residual reading.
4. To ensure stated accuracy, switch to conductance mode and verify that the open circuit reading is less than 0.10 nS.

Function	Ranges	Resolution	Accuracy
Capacitance <sup>2</sup>	1.000 nF	0.001 nF	2% + 5
	10.00 nF	0.01 nF	1 % + 5
	100.0 nF	0.1 nF	
	1.000 μF	0.001 μF	
	10.00 μF	0.01 μF	
	100.0 μF	0.1 μF	
	1,000 μF	1 μF	
	10.0 mF	0.01 mF	
	50.00 mF	0.01 mF <sup>3</sup>	3 % + 10
Diode Test <sup>1</sup>	3.1000 V	0.0001 V	2 % + 20

1. For the 5,000 count mode, divide the number of least significant digits (counts) by 10.
2. For film capacitor or better, using Relative mode (**REL Δ**) to zero residual on 1.000 nF and 10.00 nF ranges.
3. Least significant digit not active above 10 mF.

**Model 187 & 189***Users Manual*

Function	Range	Resolution	Accuracy
Frequency	500.00 Hz	0.01 Hz <sup>1</sup>	$\pm (0.0050 \% + 1)$
	5.0000 kHz	0.0001 kHz	
	50.000 kHz	0.001 kHz	
	999.99 kHz	0.01 kHz	
Duty Cycle	10.00% to 90.00 %	0.01 %	$\pm ((\text{voltage range}/\text{input voltage}) \times 300 \text{ counts})$ <sup>5,6</sup>
Pulse Width	499.99 ms	0.01 ms	$\pm (3 \% \times (\text{voltage range}/\text{input voltage}) + 1 \text{ count})$ <sup>5,6</sup>
	999.9 ms	0.1 ms	
Temperature	-200 to +1350 °C	0.1 °C	$\pm (1 \% \text{ of reading} + 1 \text{ }^\circ\text{C})$ <sup>2,3</sup>
	-328 to +2462 °F	0.1 °F	$\pm (1 \% \text{ of reading} + 1.8 \text{ }^\circ\text{F})$ <sup>2,3</sup>
MIN MAX AVG	Response: 100 ms to 80 %		Specified accuracy $\pm 12$ counts for changes > 200 ms in duration. ( $\pm 40$ counts in AC for changes > 350 ms and inputs > 25 % of range)
FAST MN MX	250 $\mu\text{s}$ <sup>4</sup>		Specified accuracy $\pm 100$ counts up to 5,000 count (full range) reading. For higher peak readings (to 20,000 counts), specified accuracy $\pm 2\%$ of reading.

1. Reading will be 0.00 for signals below 0.5 Hz.
2. Accuracy specification is relative to the user-adjustable temperature offset, and assumes ambient temperature stable to  $\pm 1 \text{ }^\circ\text{C}$ .
3. For ambient temperature changes of  $\pm 5 \text{ }^\circ\text{C}$ , rated accuracy applies after 1 hour.
4. For repetitive peaks; 2.5 ms for single events. Use DC function settings below 20 Hz. 50 mV range not specified.
5. Frequency greater than 5 Hz, except for VDC, 500 mVDC and 3000 mVDC functions; 0.5 Hz to 1 kHz. Signals centered around trigger levels.
6. Range/input ratios also apply to current functions. 500 counts or 5 % for 10 A ranges.

### Frequency Counter Sensitivity

Input Range	Approximate VAC Sensitivity (RMS Sine Wave) <sup>1</sup>		VAC Bandwidth <sup>3</sup>	Approximate VDC Trigger Levels <sup>1</sup>	VDC Bandwidth <sup>3</sup>
	15 Hz to 100 kHz <sup>2</sup>	500 kHz <sup>2</sup>			
50 mV	5 mV	10 mV	1 MHz	-5 mV & 5 mV	1 MHz
500 mV	20 mV	20 mV	1 MHz	5 mV & 65 mV	1 MHz
3000 mV	500 mV	2000 mV	800 kHz	140 mV & 200 mV	90 kHz
5 V	0.5 V	2.0 V	950 kHz	1.4 V & 2.0 V	14 kHz
50 V	5 V	5.0 V	1 MHz	0.5 V & 6.5 V	> 400 kHz
500 V	20 V	20 V	1 MHz	5 V & 65 V	> 400 kHz
1000 V	100 V	100 V	> 400 kHz	5 V & 65 V	> 400 kHz

1. Maximum input = 10 x Range (1000 V max). Noise at low frequencies and amplitudes may affect accuracy.
2. Useable at reduced sensitivity to 0.5 Hz and 1000 kHz.
3. Typical frequency bandwidth with full scale (or maximum  $2 \times 10^7$  V-Hz product) RMS sine wave.

### Burden Voltage (A, mA, $\mu$ A)

Function	Range	Burden Voltage (typical)
mA - $\mu$ A	500.00 $\mu$ A	102 $\mu$ V / $\mu$ A
	5,000 $\mu$ A	102 $\mu$ V / $\mu$ A
	50.000 mA	1.8 mV / mA
	400.00 mA	1.8 mV / mA
A	5.0000 A	0.04 V / A
	10.000 A	0.04 V / A

## Input Characteristics

Function	Input Impedance (Nominal)					
Volts, mV	10 M $\Omega$ , < 100 pF					
	Common Mode Rejection Ratio			Normal Mode Rejection		
DC Volts, mV	>100 dB at dc, 50 Hz or 60 Hz $\pm$ 0.1%			>90 dB at 50 Hz or 60 Hz $\pm$ 0.1%		
AC Volts, mV	> 90 dB dc to 60 Hz					
	Open Circuit Test Voltage			Full-Scale Voltage		
				To 5 M $\Omega$	30 M $\Omega$ + nS	
Ohms	< 5 V			500 mV	3.1 V	
Diode Test	< 5 V			3.1000 V		
	Typical Short-Circuit Current					
	500 $\Omega$	5 k $\Omega$	50 k $\Omega$	500 k $\Omega$	5 M $\Omega$	30 M $\Omega$
Ohms	1 mA	100 $\mu$ A	10 $\mu$ A	1 $\mu$ A	0.1 $\mu$ A	0.1 $\mu$ A
Diode Test	1 mA typical					